

# Aspire Series

## Generic User Guide

Copyright © 2008. Acer Incorporated.  
All Rights Reserved.

Aspire Series Generic User Guide  
Original Issue: 05/2008

Changes may be made periodically to the information in this publication without obligation to notify any person of such revisions or changes. Such changes will be incorporated in new editions of this manual or supplementary documents and publications. This company makes no representations or warranties, either expressed or implied, with respect to the contents hereof and specifically disclaims the implied warranties of merchantability or fitness for a particular purpose.

Record the model number, serial number, purchase date and place of purchase information in the space provided below. The serial number and model number are recorded on the label affixed to your computer. All correspondence concerning your unit should include the serial number, model number and purchase information.

No part of this publication may be reproduced, stored in a retrieval system, or transmitted, in any form or by any means, electronically, mechanically, by photocopy, recording or otherwise, without the prior written permission of Acer Incorporated.

Aspire Series Notebook PC

Model number: \_\_\_\_\_

Serial number: \_\_\_\_\_

Date of purchase: \_\_\_\_\_

Place of purchase: \_\_\_\_\_

Acer and the Acer logo are registered trademarks of Acer Incorporated. Other companies' product names or trademarks are used herein for identification purposes only and belong to their respective companies.

# Information for your safety and comfort

## Safety instructions

Read these instructions carefully. Keep this document for future reference. Follow all warnings and instructions marked on the product.

### Turning the product off before cleaning

Unplug this product from the wall outlet before cleaning. Do not use liquid cleaners or aerosol cleaners. Use a damp cloth for cleaning.

### CAUTION for plug as disconnecting device

Observe the following guidelines when connecting and disconnecting power to the power supply unit:

Install the power supply unit before connecting the power cord to the AC power outlet.

Unplug the power cord before removing the power supply unit from the computer.

If the system has multiple sources of power, disconnect power from the system by unplugging all power cords from the power supplies.

### CAUTION for Accessibility

Be sure that the power outlet you plug the power cord into is easily accessible and located as close to the equipment operator as possible. When you need to disconnect power to the equipment, be sure to unplug the power cord from the electrical outlet.

### CAUTION for bundled dummy cards

Your computer shipped with plastic dummies installed in the card slots. Dummies protect unused slots from dust, metal objects or other particles. Save the dummies for use when no cards are in the slots.

### CAUTION for Listening

To protect your hearing, follow these instructions.

- Increase the volume gradually until you can hear clearly and comfortably.
- Do not increase the volume level after your ears have adjusted.
- Do not listen to music at high volumes for extended periods.
- Do not increase the volume to block out noisy surroundings.
- Decrease the volume if you can't hear people speaking near you.

## Warnings

- Do not use this product near water.
- Do not place this product on an unstable cart, stand or table. If the product falls, it could be seriously damaged.
- Slots and openings are provided for ventilation to ensure reliable operation of the product and to protect it from overheating. These openings must not be blocked or covered. The openings should never be blocked by placing the product on a bed, sofa, rug or other similar surface. This product should never be placed near or over a radiator or heat register, or in a built-in installation unless proper ventilation is provided.
- Never push objects of any kind into this product through cabinet slots as they may touch dangerous voltage points or short-out parts that could result in a fire or electric shock. Never spill liquid of any kind onto or into the product.
- To avoid damage of internal components and to prevent battery leakage, do not place the product on a vibrating surface.
- Never use it under sporting, exercising, or any vibrating environment which will probably cause unexpected short current or damage rotor devices, HDD, Optical drive, and even exposure risk from lithium battery pack.

## Using electrical power

- This product should be operated from the type of power indicated on the marking label. If you are not sure of the type of power available, consult your dealer or local power company.
- Do not allow anything to rest on the power cord. Do not locate this product where people will walk on the cord.
- If an extension cord is used with this product, make sure that the total ampere rating of the equipment plugged into the extension cord does not exceed the extension cord ampere rating. Also, make sure that the total rating of all products plugged into the wall outlet does not exceed the fuse rating.
- Do not overload a power outlet, strip or receptacle by plugging in too many devices. The overall system load must not exceed 80% of the branch circuit rating. If power strips are used, the load should not exceed 80% of the power strip's input rating.
- This product's AC adapter is equipped with a three-wire grounded plug. The plug only fits in a grounded power outlet. Make sure the power outlet is properly grounded before inserting the AC adapter plug. Do not insert the plug into a non-grounded power outlet. Contact your electrician for details.



.....  
**Warning! The grounding pin is a safety feature. Using a power outlet that is not properly grounded may result in electric shock and/or injury.**



.....

**Note:** The grounding pin also provides good protection from unexpected noise produced by other nearby electrical devices that may interfere with the performance of this product.

- Use the product only with the supplied power supply cord set. If you need to replace the power cord set, make sure that the new power cord meets the following requirements: detachable type, UL listed/CSA certified, type SPT-2, rated 7 A 125 V minimum, VDE approved or its equivalent, 4.6 meters (15 feet) maximum length.

## Product servicing

Do not attempt to service this product yourself, as opening or removing covers may expose you to dangerous voltage points or other risks. Refer all servicing to qualified service personnel.

Unplug this product from the wall outlet and refer servicing to qualified service personnel when:

- the power cord or plug is damaged, cut or frayed
- liquid was spilled into the product
- the product was exposed to rain or water
- the product has been dropped or the case has been damaged
- the product exhibits a distinct change in performance, indicating a need for service
- the product does not operate normally after following the operating instructions



.....

**Note:** Adjust only those controls that are covered by the operating instructions, since improper adjustment of other controls may result in damage and will often require extensive work by a qualified technician to restore the product to normal condition.

## Guidelines for safe battery usage

This notebook uses a Lithium-ion battery. Do not use it in a humid, wet or corrosive environment. Do not put, store or leave your product in or near a heat source, in a high temperature location, in strong direct sunlight, in a microwave oven or in a pressurized container, and do not expose it to temperatures over 60°C (140°F). Failure to follow these guidelines may cause the battery to leak acid, become hot, explode or ignite and cause injury and/or damage. Do not pierce, open or disassemble the battery. If the battery leaks and you come into contact with the leaked fluids, rinse thoroughly with water and seek medical attention immediately. For safety reasons, and to prolong the lifetime of the battery, charging will not occur at temperatures below 0°C (32°F) or above 40°C (104°F).

The full performance of a new battery is achieved only after two or three complete charge and discharge cycles. The battery can be charged and

discharged hundreds of times, but it will eventually wear out. When the operation time becomes noticeably shorter than normal, buy a new battery. Use only Acer approved batteries, and recharge your battery only with Acer approved chargers designated for this device.

Use the battery only for its intended purpose. Never use any charger or battery that is damaged. Do not short-circuit the battery. Accidental short-circuiting can occur when a metallic object such as a coin, clip or pen causes direct connection of the positive (+) and negative (-) terminals of the battery. (These look like metal strips on the battery.) This might happen, for example, when you carry a spare battery in your pocket or purse. Short-circuiting the terminals may damage the battery or the connecting object.

The capacity and lifetime of the battery will be reduced if the battery is left in hot or cold places, such as in a closed car in summer or winter. Always try to keep the battery between 15°C and 25°C (59°F and 77°F). A device with a hot or cold battery may not work temporarily, even when the battery is fully charged. Battery performance is especially limited in temperatures well below freezing.

Do not dispose of batteries in a fire as they may explode. Batteries may also explode if damaged. Dispose of batteries according to local regulations. Please recycle when possible. Do not dispose as household waste.

Wireless devices may be susceptible to interference from the battery, which could affect performance.

### Replacing the battery pack

The notebook uses lithium batteries. Replace the battery with the same type as that which came bundled with your product. Use of another battery may present a risk of fire or explosion.



.....  
**Warning! Batteries may explode if not handled properly. Do not disassemble or dispose of them in fire. Keep them away from children. Follow local regulations when disposing of used batteries.**

### Telephone line safety

- Disconnect all telephone lines from the equipment when not in use and/or before servicing.
- To avoid the remote risk of electric shock from lightning, do not connect the telephone line to this equipment during lightning or thunderstorms.



.....  
**Warning! For safety reasons, do not use non-compliant parts when adding or changing components. Consult your reseller for purchase options.**

## Additional safety information

Your device and its enhancements may contain small parts. Keep them out of the reach of small children.

### Operating environment



**Warning! For safety reasons, turn off all wireless or radio transmitting devices when using your laptop under the following conditions. These devices may include, but are not limited to: wireless lan (WLAN), Bluetooth and/or 3G.**

Remember to follow any special regulations in force in any area, and always switch off your device when its use is prohibited or when it may cause interference or danger. Use the device only in its normal operating positions. This device meets RF exposure guidelines when used normally, and it and its antenna are positioned at least 1.5 centimeters (5/8 inches) away from your body (refer to the figure below). It should not contain metal and you should position the device the above-stated distance from your body. To successfully transmit data files or messages, this device requires a good quality connection to the network. In some cases, transmission of data files or messages may be delayed until such a connection is available. Ensure that the above separation distance instructions are followed until the transmission is completed. Parts of the device are magnetic. Metallic materials may be attracted to the device, and persons with hearing aids should not hold the device to the ear with the hearing aid. Do not place credit cards or other magnetic storage media near the device, because information stored on them may be erased.

### Medical devices

Operation of any radio transmitting equipment, including wireless phones, may interfere with the functionality of inadequately protected medical devices. Consult a physician or the manufacturer of the medical device to determine if they are adequately shielded from external RF energy or if you have any questions. Switch off your device in health care facilities when any regulations posted in these areas instruct you to do so. Hospitals or health care facilities may be using equipment that could be sensitive to external RF transmissions..

**Pacemakers.** Pacemaker manufacturers recommend that a minimum separation of 15.3 centimeters (6 inches) be maintained between wireless devices and a pacemaker to avoid potential interference with the pacemaker. These recommendations are consistent with the independent research by and recommendations of Wireless Technology Research. Persons with pacemakers should do the following:

- Always keep the device more than 15.3 centimeters (6 inches) from the pacemaker
- Not carry the device near your pacemaker when the device is switched o. If you suspect interference, switch off your device, and move it.

**Hearing aids.** Some digital wireless devices may interfere with some hearing aids. If interference occurs, consult your service provider.

## Vehicles

RF signals may affect improperly installed or inadequately shielded electronic systems in motor vehicles such as electronic fuel injection systems, electronic antiskid (antilock) braking systems, electronic speed control systems, and air bag systems. For more information, check with the manufacturer, or its representative, of your vehicle or any equipment that has been added. Only qualified personnel should service the device, or install the device in a vehicle. Faulty installation or service may be dangerous and may invalidate any warranty that may apply to the device. Check regularly that all wireless equipment in your vehicle is mounted and operating properly. Do not store or carry flammable liquids, gases, or explosive materials in the same compartment as the device, its parts, or enhancements. For vehicles equipped with an air bag, remember that air bags inflate with great force. Do not place objects, including installed or portable wireless equipment in the area over the air bag or in the air bag deployment area. If in-vehicle wireless equipment is improperly installed, and the air bag inflates, serious injury could result. Using your device while flying in aircraft is prohibited. Switch off your device before boarding an aircraft. The use of wireless teledevices in an aircraft may be dangerous to the operation of the aircraft, disrupt the wireless telephone network, and may be illegal.

## Potentially explosive environments

Switch off your device when in any area with a potentially explosive atmosphere and obey all signs and instructions. Potentially explosive atmospheres include areas where you would normally be advised to turn off your vehicle engine. Sparks in such areas could cause an explosion or fire resulting in bodily injury or even death. Switch off the device at refueling points such as near gas pumps at service stations. Observe restrictions on the use of radio equipment in fuel depots, storage, and distribution areas; chemical plants; or where blasting operations are in progress. Areas with a potentially explosive atmosphere are often, but not always, clearly marked. They include below deck on boats, chemical transfer or storage facilities, vehicles using liquefied petroleum gas (such as propane or butane), and areas where the air contains chemicals or particles such as grain, dust or metal powders. Do not switch the notebook on when wireless phone use is prohibited or when it may cause interference or danger.

## Emergency calls

**Warning:** You cannot make emergency calls through this device. To make an emergency call you shall dial out through your mobile phone or other telephone call system.



## Disposal instructions

Do not throw this electronic device into the trash when discarding. To minimize pollution and ensure utmost protection of the global environment, please recycle. For more information on the Waste from Electrical and Electronics Equipment (WEEE) regulations, visit <http://global.acer.com/about/sustainability.htm>



### Mercury advisory

For projectors or electronic products containing an LCD/CRT monitor or display: Lamp(s) inside this product contain mercury and must be recycled or disposed of according to local, state or federal laws. For more information, contact the Electronic Industries Alliance at [www.eiae.org](http://www.eiae.org). For lamp-specific disposal information, check [www.lamprecycle.org](http://www.lamprecycle.org).





ENERGY STAR

ENERGY STAR is a government program (public/private partnership) that gives people the power to protect the environment in a cost effective way and without sacrificing quality or product features. Products that earn the ENERGY STAR prevent greenhouse gas emissions by meeting strict energy efficiency guidelines set by the US Environmental Protection Agency (EPA) and the US Department of Energy (DOE). In the average home, 75% of all electricity used to power home electronics is consumed while the products are turned off. ENERGY STAR qualified home electronic products in the off position use up to 50% less energy than conventional equipment. More information refers to <http://www.energystar.gov> and <http://www.energystar.gov/powermanagement>.



**Note:** The statement above is applicable only to Acer notebooks with an ENERGY STAR sticker located in the bottom right-hand corner of the palm rest.

As an ENERGY STAR partner, Acer Inc. has determined that this product meets the ENERGY STAR guidelines for energy efficiency.

This product has been shipped enabled for power management:

- Activate display' Sleep mode within 15 minutes of user inactivity.
- Activate computer's Sleep mode within 30 minutes of user inactivity.
- Wake the computer from Sleep mode by pushing power button.
- More power management settings can be done through Acer ePower Management.

## Tips and information for comfortable use

Computer users may complain of eyestrain and headaches after prolonged use. Users are also at risk of physical injury after long hours of working in front of a computer. Long work periods, bad posture, poor work habits, stress, inadequate working conditions, personal health and other factors greatly increase the risk of physical injury.

Incorrect computer usage may lead to carpal tunnel syndrome, tendonitis, tenosynovitis or other musculoskeletal disorders. The following symptoms may appear in the hands, wrists, arms, shoulders, neck or back:

- numbness, or a burning or tingling sensation
- aching, soreness or tenderness
- pain, swelling or throbbing
- stiffness or tightness
- coldness or weakness

If you have these symptoms, or any other recurring or persistent discomfort and/or pain related to computer use, consult a physician immediately and inform your company's health and safety department.

The following section provides tips for more comfortable computer use.

## Finding your comfort zone

Find your comfort zone by adjusting the viewing angle of the monitor, using a footrest, or raising your sitting height to achieve maximum comfort. Observe the following tips:

- refrain from staying too long in one fixed posture
- avoid slouching forward and/or leaning backward
- stand up and walk around regularly to remove the strain on your leg muscles
- take short rests to relax your neck and shoulders
- avoid tensing your muscles or shrugging your shoulders
- install the external display, keyboard and mouse properly and within comfortable reach
- if you view your monitor more than your documents, place the display at the center of your desk to minimize neck strain

## Taking care of your vision

Long viewing hours, wearing incorrect glasses or contact lenses, glare, excessive room lighting, poorly focused screens, very small typefaces and low-contrast displays could stress your eyes. The following sections provide suggestions on how to reduce eyestrain.

### Eyes

- Rest your eyes frequently.
- Give your eyes regular breaks by looking away from the monitor and focusing on a distant point.
- Blink frequently to keep your eyes from drying out.

### Display

- Keep your display clean.
- Keep your head at a higher level than the top edge of the display so your eyes point downward when looking at the middle of the display.
- Adjust the display brightness and/or contrast to a comfortable level for enhanced text readability and graphics clarity.
- Eliminate glare and reflections by:
  - placing your display in such a way that the side faces the window or any light source
  - minimizing room light by using drapes, shades or blinds
  - using a task light
  - changing the display's viewing angle
  - using a glare-reduction filter
  - using a display visor, such as a piece of cardboard extended from the display's top front edge
- Avoid adjusting your display to an awkward viewing angle.

- Avoid looking at bright light sources, such as open windows, for extended periods of time.

## Developing good work habits

Develop the following work habits to make your computer use more relaxing and productive:

- Take short breaks regularly and often.
- Perform some stretching exercises.
- Breathe fresh air as often as possible.
- Exercise regularly and maintain a healthy body.



.....

**Warning! We do not recommend using the computer on a couch or bed. If this is unavoidable, work for only short periods, take breaks regularly, and do some stretching exercises.**



.....

**Note:** For more information, please refer to "**Regulations and safety notices**" on page 73 in the **AcerSystem User Guide**.

# First things first

We would like to thank you for making an Acer notebook your choice for meeting your mobile computing needs.

## Your guides

To help you use your Acer notebook, we have designed a set of guides:

First off, the **Just for Starters...** poster helps you get started with setting up your computer.

The printed **Aspire Series Generic User Guide** contains useful information applying to all models in the Aspire product series. It covers basic topics such as Acer's Empowering Technology, using the keyboard, Audio, etc. Please understand that due to its nature, the **Generic User Guide** as well as the **AcerSystem User Guide** mentioned below will occasionally refer to functions or features which are only contained in certain models of the series, but not necessarily in the model you purchased. Such instances are marked in the text with language such as "only for certain models".

The printed **Quick Guide** introduces you to the basic features and functions of your new computer. For more on how your computer can help you to be more productive, please refer to the **AcerSystem User Guide**. This guide contains detailed information on such subjects as system utilities, data recovery, expansion options and troubleshooting. In addition it contains warranty information and the general regulations and safety notices for your notebook. It is available in Portable Document Format (PDF) and comes preloaded on your notebook. Follow these steps to access it:

- 1 Click on  **Start, All Programs, AcerSystem.**
- 2 Click on **AcerSystem User Guide.**



.....

**Note:** Viewing the file requires Adobe Reader. If Adobe Reader is not installed on your computer, clicking on **AcerSystem User Guide** will run the Adobe Reader setup program first. Follow the instructions on the screen to complete the installation. For instructions on how to use Adobe Reader, access the **Help and Support** menu.

## Basic care and tips for using your computer

### Turning your computer on and off

To turn on the computer, simply press and release the power button below the LCD screen beside the easy-launch buttons. Please refer to "**Quick Guide**" for the location of the power button.

To turn the power off, do any of the following:

- Use the Windows shutdown command

Click on **Start**  then click on **Shut Down**.

- Use the power button

You can also put the computer in sleep mode by pressing the sleep hotkey **<Fn> + <F4>**.



**Note:** If you cannot power off the computer normally, press and hold the power button for more than four seconds to shut down the computer. If you turn off the computer and want to turn it on again, wait at least two seconds before powering up.

## Taking care of your computer

Your computer will serve you well if you take care of it.

- Do not expose the computer to direct sunlight. Do not place it near sources of heat, such as a radiator.
- Do not expose the computer to temperatures below 0 °C (32 °F) or above 50 °C (122 °F).
- Do not subject the computer to magnetic fields.
- Do not expose the computer to rain or moisture.
- Do not spill water or any liquid on the computer.
- Do not subject the computer to heavy shock or vibration.
- Do not expose the computer to dust or dirt.
- Never place objects on top of the computer.
- Do not slam the computer display when you close it.
- Never place the computer on uneven surfaces.

## Taking care of your AC adapter

Here are some ways to take care of your AC adapter:

- Do not connect the adapter to any other device.
- Do not step on the power cord or place heavy objects on top of it. Carefully route the power cord and any cables away from foot traffic.
- When unplugging the power cord, do not pull on the cord itself but pull on the plug.
- The total ampere ratings of the equipment plugged in should not exceed the ampere rating of the cord if you are using an extension cord. Also, the total current rating of all equipment plugged into a single wall outlet should not exceed the fuse rating.

## Taking care of your battery pack

Here are some ways to take care of your battery pack:

- Use only batteries of the same kind as replacements. Turn the power off before removing or replacing batteries.
- Do not tamper with batteries. Keep them away from children.
- Dispose of used batteries according to local regulations. Recycle if possible.

## Cleaning and servicing

When cleaning the computer, follow these steps:

- 1 Turn off the computer and remove the battery pack.
- 2 Disconnect the AC adapter.
- 3 Use a soft, moist cloth. Do not use liquid or aerosol cleaners.

If either of the following occurs:

- the computer has been dropped or the body has been damaged;
- the computer does not operate normally

Please refer to "**Frequently asked questions**" on page 29 .





<b>Information for your safety and comfort</b>	<b>iii</b>
Safety instructions	iii
Additional safety information	vii
Operating environment	vii
Medical devices	vii
Vehicles	viii
Potentially explosive environments	viii
Emergency calls	viii
Disposal instructions	ix
Tips and information for comfortable use	x
<b>First things first</b>	<b>xiii</b>
Your guides	xiii
Basic care and tips for using your computer	xiii
Turning your computer on and off	xiii
Taking care of your computer	xiv
Taking care of your AC adapter	xiv
Taking care of your battery pack	xv
Cleaning and servicing	xv
<b>Acer Empowering Technology</b>	<b>1</b>
Launching Acer Empowering Technology	1
Empowering Technology password	3
Acer eAudio Management (only for certain models)	5
Acer ePower Management	6
Acer eDataSecurity Management (only for certain models)	9
Acer eRecovery Management	11
Acer eSettings Management	13
Windows Mobility Center	14
<b>Indicators</b>	<b>15</b>
<b>Easy-launch buttons</b>	<b>16</b>
<b>Touchpad</b>	<b>17</b>
Touchpad basics (with fingerprint reader)	17
Touchpad basics (with two-click buttons)	18
<b>Using a computer security lock</b>	<b>19</b>
<b>Using the keyboard</b>	<b>20</b>
Lock keys and embedded numeric keypad	20
Windows keys	21
Hotkeys	22
Special keys (only for certain models)	23
<b>Audio</b>	<b>24</b>
Acer PureZone (only for certain models)	24
Tuba (only for certain models)	24
Using Dolby Home Theater for surround/ multi-channel	

# Contents

sound (only for certain models)	24
<b>Video</b>	<b>25</b>
16:9 display (only for certain models)	25
<b>Using the system utilities</b>	<b>26</b>
Acer Bio-Protection (only for certain models)	26
Acer GridVista (dual-display compatible)	27
<b>Frequently asked questions</b>	<b>29</b>
Requesting service	32
International Travelers Warranty (ITW)	32
Before you call	32
<b>Battery pack</b>	<b>33</b>
Battery pack characteristics	33
Maximizing the battery's life	33
Installing and removing the battery pack	34
Charging the battery	35
Checking the battery level	35
Optimising battery life	35
Battery-low warning	36
<b>Acer Arcade Deluxe</b>	<b>37</b>
General controls	37
Navigation controls	38
Player controls	38
Cinema	38
Movies:	38
Videos:	39
Playing a video file:	39
Recent Videos:	39
HomeMedia	40
Advanced	40
Live Update:	40
Albums	42
Editing Pictures	42
Slideshow settings	43
Snapshot	43
Music	43
Background mode	43
<b>Taking your notebook PC with you</b>	<b>44</b>
Disconnecting from the desktop	44
Moving around	44
Preparing the computer	44
What to bring to meetings	45
Taking the computer home	45
Preparing the computer	45
What to take with you	45
Special considerations	46

Setting up a home office	46
Traveling with the computer	46
Preparing the computer	46
What to take with you	46
Special considerations	47
Traveling internationally with the computer	47
Preparing the computer	47
What to bring with you	47
Special considerations	47
<b>Securing your computer</b>	<b>48</b>
Using a computer security lock	48
Using passwords	48
Entering passwords	49
Setting passwords	49
<b>Expanding through options</b>	<b>50</b>
Connectivity options	50
Fax/data modem	50
Built-in network feature	51
Consumer Infrared (CIR) (only for certain models)	51
Universal Serial Bus (USB)	52
IEEE 1394 port (only for certain models)	52
High-Definition Multimedia Interface (only for certain models)	53
ExpressCard	53
Installing memory	54
Connecting your TV and AV-in cables (only for certain models)	56
BIOS utility	59
Boot sequence	59
Enable disk-to-disk recovery	59
Password	59
Using software	60
Playing DVD movies	60
<b>Power management</b>	<b>61</b>
<b>Acer eRecovery Management</b>	<b>62</b>
Burn backup discs	63
Create a user backup	64
Manage user backups	66
Restore	67
Restore Windows Vista from backup discs	68
<b>Troubleshooting</b>	<b>71</b>
Troubleshooting tips	71
Error messages	71
<b>Regulations and safety notices</b>	<b>73</b>
FCC notice	73

Modem notices	74
Laser compliance statement	77
LCD pixel statement	77
Radio device regulatory notice	78
General	78
European Union (EU)	78
The FCC RF safety requirement	79
Canada — Low-power license-exempt radio communication devices (RSS-210)	80
LCD panel ergonomic specifications	81
<b>Index</b>	<b>82</b>

# Acer Empowering Technology

The Empowering Technology toolbar makes it easy for you to access frequently used functions and manage your new Acer system. Activated by pressing the Empowering Key, it provides access to the following utilities:



-----

**Note:** The following content is for general reference only. Actual product specifications may vary.

- **Acer eAudio Management** allows you to easily control the enhanced sound effects of Dolby Home Theater on your system (only for certain models).
- **Acer ePower Management** optimizes battery usage via customizable power plans.
- **Acer eDataSecurity Management** protects data with passwords and encryption (only for certain models).
- **Acer eRecovery Management** backs up and recovers data flexibly, reliably and completely.
- **Acer eSettings Management** accesses system information and adjusts settings easily.



For more information, right-click on the Empowering Technology toolbar, then select **Help**. For help with a particular utility, launch the utility and click the  icon at the bottom of the active window.

## Launching Acer Empowering Technology

To launch Acer Empowering Technology:

- 1 Press the Empowering Key to display the Acer Empowering Technology toolbar on the desktop.
- 2 To hide the toolbar, press the Empowering Key again or click the hide button  on the toolbar.

You may also launch Acer Empowering Technology by running the program from the Acer Empowering Technology program group in the Start menu, or by double-clicking the  icon if you have created a desktop shortcut.

Empowering  
Technology



## To launch Acer Empowering Technology applications:

- 1 On the Acer Empowering Technology toolbar, click the icon that corresponds to the application you want to launch.
- 2 When you mouse over an application icon, a quick menu appears below the toolbar. The quick menu allows you to perform certain tasks simply and quickly.



- 3 You may also run the application by selecting it from the Acer Empowering Technology program group in the Start menu.



**Note:** You may also double-click or right-click  to run Acer eAudio Management, and right-click  to run Acer ePower Management from the system tray.

## Empowering Technology password

You must set the Empowering Technology password to use the password protection feature of Acer eRecovery Management to protect your data.

To set the Empowering Technology password:

- 1 Launch Acer eRecovery Management.
- 2 Click the Restore tab.
- 3 Click **Password settings**. The Empowering Technology Password Center dialog box pops up.
- 4 Click **Create a new password**.



- 5 In the Create a New Password dialog box, key in and confirm your password in the appropriate boxes. Your password should have a minimum of 4 and a maximum of 12 characters.
- 6 Enter a password hint that will help you remember your password.
- 7 Make sure the box **Use for Acer eRecovery Management** is checked.

4

8 Click **OK** to set the password.





## Acer eAudio Management

(only for certain models)

Acer eAudio Management allows you to easily control the enhanced sound effects of Dolby Home Theater on your system. Select **Movie** or **Game** mode to experience the awesome realism of 5.1-channel audio output from the speakers fitted to your system via Dolby Surround sound technology. **Music** mode lets you enjoy your favorite tunes, in vivid detail.



To choose your playback device, click the  icon on the upper right side of the Acer eAudio Management window.



## Acer ePower Management

Acer ePower Management features a straightforward user interface for configuring your power management options. To access this utility, select **Acer ePower Management** from the Empowering Technology toolbar, run the program from the Acer Empowering Technology program group in Start menu, or right-click the Windows power icon in the system tray and select **Acer ePower Management**.

### Using power plans

Acer ePower Management comes with three predefined power plans: **Balanced**, **High performance** and **Power saver**.

View and adjust settings for **On Battery** and **Plugged In** modes by clicking the appropriate tabs. For more power options, click  in the Acer ePower Management utility, or right-click the Windows power icon in the system tray and select **Power Options**.

You can also create customized power plans. You can create, switch between, edit, delete and restore power plans, as described below.

### To create a new power plan:

Creating customized power plans allows you to save and quickly switch to a personalized set of power options.

- 1 Click the **New power plan** option or icon .
- 2 Enter a name for your new power plan.
- 3 Choose a predefined power plan to base your customized plan on.
- 4 If necessary, change the display, sleep and hibernation settings you want your computer to use.
- 5 Click **OK** to save your new power plan.

### To switch between power plans:

- 1 Move your mouse over the Acer ePower Management  application on the Acer Empowering Technology toolbar. The quick menu appears.  
Select the power plan you want to switch to.
- 2 You may also switch between power plans by launching the Acer ePower Management application.  
Select the power plan you wish to switch to, then click **Apply**.

## To edit a power plan:

Editing a power plan allows you to adjust system settings like LCD brightness, CPU speed and Graphics power mode (only for certain models).

- 1 Switch to the power plan you wish to edit.
- 2 Adjust settings as required.
- 3 Click **Apply** or **Save** to save your new settings.



-----

**Note:** You can revert to the default settings of the predefined power plans by clicking the **Restore** button.

## To delete a power plan:

You cannot delete the power plan you are currently using. The active power plan will mark with  in upper left corner of power plan icon. If you want to delete the active power plan, switch to another one first.

- 1 Select the power plan you wish to delete.
- 2 Click the Delete this plan icon. 



-----

**Note:** You cannot delete the predefined power plans, but you can modify the settings of the predefined power plans.

## Battery status

- 1 The quick menu shows the remaining battery life based on current usage.
- 2 You can also launch the Acer ePower Management application and refer to the Battery status panel located just below the power plans.

- 3 Click the Battery tab to view remaining battery life, battery status, and remaining battery life in standby and hibernate modes.



## Acer eDataSecurity Management

### (only for certain models)

Acer eDataSecurity Management is an encryption utility that protects your files from being accessed by unauthorized persons. It is conveniently integrated with Windows Explorer as a shell extension for quick data encryption/decryption and also supports on-the-fly file encryption for Lotus Notes and Microsoft Outlook.

On first use, the Acer eDataSecurity Management setup wizard will prompt you to create the Master Password. You will use this password to access the Personal Secure Disk (PSD). The Master Password may also be used to encrypt/decrypt files by default.

If you set a different password to encrypt a file, but you forgot the encryption password, you can use the Master Password to decrypt the file.



**Note:** The password used to encrypt a file is the unique key that the system needs to decrypt it. If you lose the password, the Master Password is the only other key capable of decrypting the file. If you lose both passwords, there will be no way to decrypt your encrypted file! **Be sure to safeguard all related passwords!**



## Acer eRecovery Management

Acer eRecovery Management is a versatile backup utility. It allows you to create full or incremental backups, burn the factory default image to optical disc, and restore from previously created backups or reinstall applications and drivers. By default, user-created backups are stored to the D:\ drive.

Acer eRecovery Management provides you with:

- Backup:
  - Back up factory default to CD/DVD
  - Back up drivers and applications to CD/DVD
  - Create user backup
  - Manage user backups
- Restore:
  - Restore system to factory default
  - Reinstall applications/drivers
  - Restore system from user backup
  - Password settings

To use the password protection feature of Acer eRecovery Management to protect your data, you must first set the Empowering Technology password. To set the password, refer to the section "**Empowering Technology password**".



For more information, please refer to "**Acer eRecovery Management**" on page 62 in the **Acer System User Guide**.



.....

**Note:** If your computer did not come with a Recovery CD or System CD, please use Acer eRecovery Management's Backup factory default to CD/DVD feature to burn a backup image to CD or DVD. To ensure the best results when recovering your system using a CD or Acer eRecovery Management, detach all peripherals (except the external Acer ODD, if your computer has one), including your Acer ezDock.



## Acer eSettings Management

Acer eSettings Management allows you to inspect hardware specifications, set BIOS passwords and modify boot options.

Acer eSettings Management also:

- Provides a simple graphical user interface for navigation.
- Prints and saves hardware specifications.
- Lets you set an asset tag for your system.



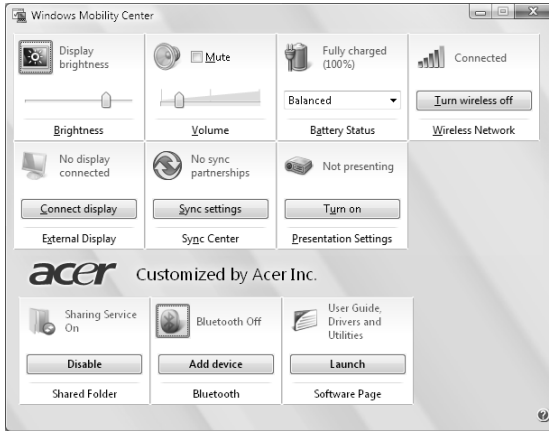

## Windows Mobility Center



The Windows Mobility Center collects key mobile-related system settings in one easy-to-find place, so you can quickly configure your Acer system to fit the situation as you change locations, networks or activities. Settings include display brightness, volume, power plan, wireless networking on/off, external display settings, synchronization status and presentation settings.





Windows Mobility Center also includes Acer-specific settings like sharing folders overview/sharing service on or off, Bluetooth Add Device (if applicable), and a shortcut to the Acer user guide, drivers and utilities.

To launch Windows Mobility Center:

- Use the shortcut key <  > + <X>.
- Start Windows Mobility Center from the Control panel.
- Start Windows Mobility Center from the Accessories program group in the Start menu.
- Launch Windows Mobility Center by right-clicking  in the system tray and select **Windows Mobility Center**.

# Indicators

The computer has several easy-to-read status indicators. The front panel indicators are visible even when the computer cover is closed up.

Icon	Function	Description
	HDD	Indicates when the hard disk drive is active.
	Num Lock	Lights up when Num Lock is activated.
	Caps Lock	Lights up when Caps Lock is activated.
	Power	Indicates the computer's power status.
	Battery	Indicates the computer's battery status.









- .....
- 1. Charging:** The light shows amber when the battery is charging.
  - 2. Fully charged:** The light shows green when in AC mode.

## Easy-launch buttons

Located beside the keyboard are application buttons. These buttons are called easy-launch buttons. They are: WLAN, Internet, email, Bluetooth, Arcade and Acer Empowering Technology.

The mail and Web browser buttons are pre-set to email and Internet programs, but can be reset by users. To set the Web browser, mail and programmable buttons, run the Acer Launch Manager. You can access the Launch Manager by clicking on **Start, All Programs**, and then **Launch Manager** to start the application.

Icon	Function	Description
	Wireless communication button/indicator (manufacturing option)	Enables/disables the wireless function. Indicates the status of wireless LAN communication.
	Web browser	Internet browser (user-Programmable)
	Mail	Email application (user-Programmable)
	Bluetooth communication button/indicator (manufacturing option)	Enables/disables the Bluetooth function. Indicates the status of Bluetooth communication.
	Arcade	Launch Acer Arcade utility (only for certain models).
	Acer Empowering Technology	Launch Acer Empowering Technology (user-programmable)

# Touchpad

The built-in touchpad is a pointing device that senses movement on its surface. This means the cursor responds as you move your finger across the surface of the touchpad. The central location on the palmrest provides optimum comfort and support.

## Touchpad basics (with fingerprint reader)

The following items show you how to use the touchpad with Acer Bio-Protection fingerprint reader.

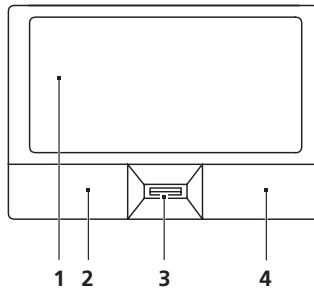

- Move your finger across the touchpad **(1)** to move the cursor.
- Press the left **(2)** and right **(4)** buttons located beneath the touchpad to perform selection and execution functions. These two buttons are similar to the left and right buttons on a mouse. Tapping on the touchpad is the same as clicking the left button.
- Use Acer Bio-Protection fingerprint reader **(3)** supporting Acer FingerNav 4-way control function (only for certain models) to scroll up or down and move left or right a page. This fingerprint reader or button mimics your cursor pressing on the right scroll bar of Windows applications.

Function	Left button (2)	Right button (4)	Main touchpad (1)	Center button (3)
Execute	Quickly click twice.		Tap twice (at the same speed as double-clicking a mouse button).	
Select	Click once.		Tap once.	
Drag	Click and hold, then use finger on the touchpad to drag the cursor.		Tap twice (at the same speed as double-clicking a mouse button); rest your finger on the touchpad on the second tap and drag the cursor.	

Function	Left button (2)	Right button (4)	Main touchpad (1)	Center button (3)
Access context menu		Click once.		
Scroll				Swipe up/down/left/right using Acer FingerNav 4-way control function (Manufacturing option).

## Touchpad basics (with two-click buttons)

The following items show you how to use the touchpad with two-click buttons.

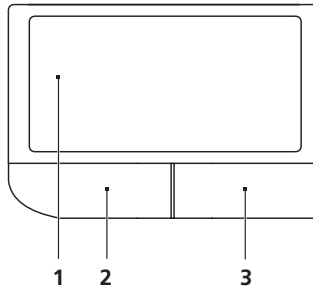

- Move your finger across the touchpad **(1)** to move the cursor.
- Press the left **(2)** and right **(3)** buttons located beneath the touchpad to perform selection and execution functions. These two buttons are similar to the left and right buttons on a mouse. Tapping on the touchpad is the same as clicking the left button.

Function	Left button (2)	Right button (3)	Main touchpad (1)
Execute	Quickly click twice.		Tap twice (at the same speed as double-clicking a mouse button).
Select	Click once.		Tap once.
Drag	Click and hold, then use finger on the touchpad to drag the cursor.		Tap twice (at the same speed as double-clicking a mouse button); rest your finger on the touchpad on the second tap and drag the cursor.
Access context menu		Click once.	



.....

**Note:** Illustrations for reference only. The exact configuration of your PC depends on the model purchased.



.....

**Note:** When using the touchpad, keep it — and your fingers — dry and clean. The touchpad is sensitive to finger movement; hence, the lighter the touch, the better the response. Tapping harder will not increase the touchpad's responsiveness.



.....

**Note:** By default, vertical and horizontal scrolling is enabled on your touchpad. It can be disabled under Mouse settings in Windows Control Panel.

## Using a computer security lock

The notebook comes with a Kensington-compatible security slot for a security lock.

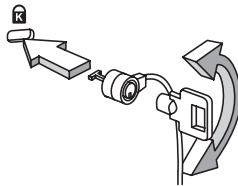

Wrap the computer security lock cable around an immovable object such as a table or handle of a locked drawer. Insert the lock into the notch and turn the key to secure the lock. Some keyless models are also available.

# Using the keyboard

The keyboard has full-sized keys and an embedded numeric keypad, separate cursor, lock, Windows, function and special keys.

## Lock keys and embedded numeric keypad

The keyboard has three lock keys which you can toggle on and off.

Lock key	Description
Caps Lock	When Caps Lock is on, all alphabetic characters typed are in uppercase.
Num Lock <Fn> + <F11>	When Num Lock is on, the embedded keypad is in numeric mode. The keys function as a calculator (complete with the arithmetic operators +, -, *, and /). Use this mode when you need to do a lot of numeric data entry. A better solution would be to connect an external keypad.
	 <p style="text-align: center;"><b>Note: &lt;Fn&gt; + &lt;F11&gt; only for certain models.</b></p>
Scroll Lock <Fn> + <F12>	When Scroll Lock is on, the screen moves one line up or down when you press the up or down arrow keys respectively. Scroll Lock does not work with some applications.





















The embedded numeric keypad functions like a desktop numeric keypad. It is indicated by small characters located on the upper right corner of the keycaps. To simplify the keyboard legend, cursor-control key symbols are not printed on the keys.

Desired access	Num Lock on	Num Lock off
Number keys on embedded keypad	Type numbers in a normal manner.	
Cursor-control keys on embedded keypad	Hold <Shift> while using cursor-control keys.	Hold <Fn> while using cursor-control keys.
Main keyboard keys	Hold <Fn> while typing letters on embedded keypad.	Type the letters in a normal manner.













# Windows keys

The keyboard has two keys that perform Windows-specific functions.

Key	Description
 Windows key	<p>Pressed alone, this key has the same effect as clicking on the Windows Start button; it launches the Start menu. It can also be used with other keys to provide a variety of functions:</p> <ul style="list-style-type: none"> <li>&lt;  &gt;: Open or close the Start menu</li> <li>&lt;  &gt; + &lt;D&gt;: Display the desktop</li> <li>&lt;  &gt; + &lt;E&gt;: Open Windows Explore</li> <li>&lt;  &gt; + &lt;F&gt;: Search for a file or folder</li> <li>&lt;  &gt; + &lt;G&gt;: Cycle through Sidebar gadgets</li> <li>&lt;  &gt; + &lt;L&gt;: Lock your computer (if you are connected to a network domain), or switch users (if you're not connected to a network domain)</li> <li>&lt;  &gt; + &lt;M&gt;: Minimizes all windows</li> <li>&lt;  &gt; + &lt;R&gt;: Open the Run dialog box</li> <li>&lt;  &gt; + &lt;T&gt;: Cycle through programs on the taskbar</li> <li>&lt;  &gt; + &lt;U&gt;: Open Ease of Access Center</li> <li>&lt;  &gt; + &lt;X&gt;: Open Windows Mobility Center</li> <li>&lt;  &gt; + &lt;BREAK&gt;: Display the System Properties dialog box</li> <li>&lt;  &gt; + &lt;SHIFT+M&gt;: Restore minimized windows to the desktop</li> <li>&lt;  &gt; + &lt;TAB&gt;: Cycle through programs on the taskbar by using Windows Flip 3-D</li> <li>&lt;  &gt; + &lt;SPACEBAR&gt;: Bring all gadgets to the front and select Windows Sidebar</li> <li>&lt;CTRL&gt; + &lt;  &gt; + &lt;F&gt;: Search for computers (if you are on a network)</li> <li>&lt;CTRL&gt; + &lt;  &gt; + &lt;TAB&gt;: Use the arrow keys to cycle through programs on the taskbar by using Windows Flip 3-D</li> </ul> <p> .....</p> <p><b>Note:</b> Depending on your edition of Windows Vista, some shortcuts may not function as described.</p>
 Application key	This key has the same effect as clicking the right mouse button; it opens the application's context menu.

## Hotkeys

The computer employs hotkeys or key combinations to access most of the computer's controls like screen brightness, volume output and the BIOS utility. To activate hotkeys, press and hold the <Fn> key before pressing the other key in the hotkey combination.

Hotkey	Icon	Function	Description
<Fn> + <F1>		Hotkey help	Displays help on hotkeys.
<Fn> + <F2>		Acer eSettings	Launches Acer eSettings in Acer Empowering Technology. See " <b>Acer Empowering Technology</b> " on page 1.
<Fn> + <F3>		Acer ePower Management	Launches Acer ePower Management in Acer Empowering Technology. See " <b>Acer Empowering Technology</b> " on page 1.
<Fn> + <F4>		Sleep	Puts the computer in Sleep mode.
<Fn> + <F5>		Display toggle	Switches display output between the display screen, external monitor (if connected) and both.
<Fn> + <F6>		Screen blank	Turns the display screen backlight off to save power. Press any key to return.
<Fn> + <F7>		Touchpad toggle	Turns the internal touchpad on and off.
<Fn> + <F8>		Speaker toggle	Turns the speakers on and off.
<Fn> + <▷>		Brightness up	Increases the screen brightness.
<Fn> + <◁>		Brightness down	Decreases the screen brightness.
<Fn> + <△>		Volume up	Increases the sound volume (only for certain models).
<Fn> + <▽>		Volume down	Decreases the sound volume (only for certain models).

## Special keys (only for certain models)

You can locate the Euro symbol and the US dollar sign at the upper-center and/or bottom-right of your keyboard.

### The Euro symbol

- 1 Open a text editor or word processor.
- 2 Either press < € > at the bottom-right of the keyboard, or hold <Alt Gr> and then press the <5> key at the upper-center of the keyboard.



.....

**Note:** Some fonts and software do not support the Euro symbol. Please refer to [www.microsoft.com/typography/faq/faq12.htm](http://www.microsoft.com/typography/faq/faq12.htm) for more information.

### The US dollar sign

- 1 Open a text editor or word processor.
- 2 Either press < \$ > at the bottom-right of the keyboard, or hold <Shift> and then press the <4> key at the upper-center of the keyboard.



.....

**Note:** This function varies according to the language settings.

# Audio

The computer also comes with 32-bit High Definition (HD) Audio, and stereo speakers.

## Acer PureZone (only for certain models)

The system provides you whole new enthusiastic audio experience including Acer PureZone with built-in stereo microphones featuring beam forming and echo cancellation technologies. Acer PureZone technology supports Acoustic Echo Cancellation, Beam Forming and Noise Suppression for pure sound recording. To set up your microphone, run the Acer HD Audio Manager by double-clicking the Acer HD Audio Manager icon in the system tray of your Windows system. The Acer HD Audio Manager dialog box will pop up. Click the Microphone tab, and then click the Microphone Effects tab. Select Beam Forming and Acoustic Echo Cancellation to set the microphone effect.



**Note:** Disable the beam forming to get the multi-sound source input.

## Tuba (only for certain models)

The dedicated Tuba CineBass subwoofer pumps out earthshaking movie-house audio. The innovative design integrates the subwoofer with the tube-style hinge.

## Using Dolby Home Theater for surround/multi-channel sound (only for certain models)

Your Acer notebook comes with the Dolby Home Theater<sup>®</sup> audio enhancement featuring Dolby Pro Logic IIx, Dolby Digital Live, Dolby Headphone, Dolby Natural Bass and Dolby Sound Space Expander technologies to give you high-quality digital surround sound for enjoying movies, games and music in a realistic, multi-channel audio environment.

### Dolby Pro Logic IIx

Dolby Pro Logic IIx creates a vivid 5.1-channel surround sound experience from any stereo (two-channel) movie, music, TV, or game audio source. Dolby Pro Logic IIx examines the signal and uses that information to expand audio into up to 5.1 channels of highly realistic, natural surround sound.

### Dolby Digital Live

Dolby Digital Live converts any audio signal in real time from PCs or game consoles into Dolby Digital for easy connection to home theater systems

through a single digital cable. Users can enjoy PC or game audio entertainment with exciting realism through home theater receivers or other devices equipped with Dolby Digital decoding technology.

### Dolby Headphone

Dolby Headphone creates a personal surround sound experience using any set of headphones. The playback of music, movies, and games results in sound that is more spacious, open, and dramatic, improving listening comfort and making listeners feel as if the action is happening all around them.

### Dolby Natural Bass

A bass enhancement system, which provides up to an octave of downward extension in the bass response of most speakers.

### Dolby Sound Space Expander

A sound stage enhancer, which produces a wide stereo image and improves the separation of instruments without diminishing the center of the mix.

## Video

### 16:9 display (only for certain models)

16:9 display delivers Full HD movies at home like never before. Sky-high color saturation guarantees an authentic HD viewing experience. 16:9 quality means true home theater visuals have finally arrived for notebook entertainment enthusiasts.

# Using the system utilities

## Acer Bio-Protection (only for certain models)

Acer Bio-Protection Fingerprint Solution is a multi-purpose fingerprint software package integrated with the Microsoft Windows operating system. Utilizing the uniqueness of one's fingerprint features, Acer Bio-Protection Fingerprint Solution has incorporated protection against unauthorized access to your computer with centralized password management with Password Bank, easy music player launching with Acer MusicLaunch, secure Internet favorites via Acer MyLaunch, and fast application/website launching and login with Acer FingerLaunch, while Acer ProfileLaunch can launch up to three applications/websites from a single finger swipe.

Acer Bio-Protection Fingerprint Solution also allows you to navigate through web browsers and documents using Acer FingerNav. With Acer Bio-Protection Fingerprint Solution, you can now enjoy an extra layer of protection for your personal computer, as well as the convenience of accessing your daily tasks with a simple swipe of your finger!

For more information refer to the Acer Bio-Protection help files.

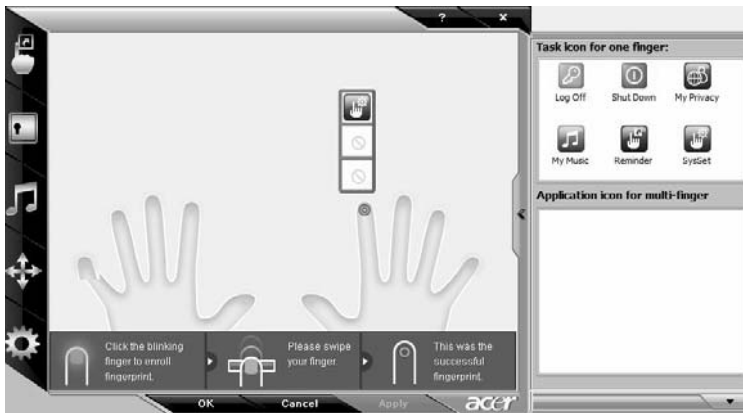

## Acer GridVista (dual-display compatible)



**Note:** This feature is only available on certain models.

To enable the dual display feature of your notebook, first ensure that a second display is connected, then, open the Display Settings properties box using the Control Panel or by right-clicking the Windows desktop and selecting **Personalize**. Select the secondary monitor (**2**) icon in the display box and then click the check box **Extend the desktop onto this monitor**. Finally, click **Apply** to confirm the new settings and click **OK** to complete the process.

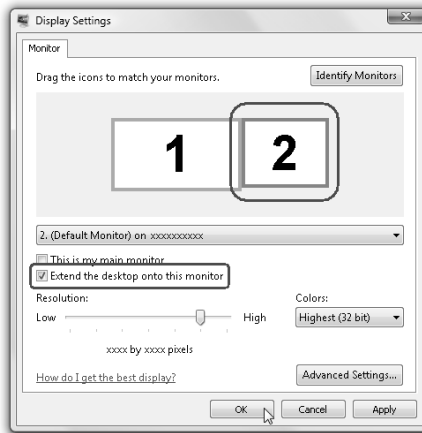

Acer GridVista is a handy utility that offers four pre-defined display settings so you can view multiple windows on the same screen. To access this function, please go to **Start, All Programs** and click on **Acer GridVista**. You may choose any one of the four display settings indicated below:

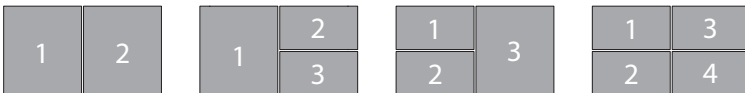

Double (vertical), Triple (primary at left), Triple (primary at right), or Quad

Acer GridVista is dual-display compatible, allowing two displays to be partitioned independently.

Acer GridVista is simple to set up:

- 1 Run Acer GridVista and select your preferred screen configuration for each display from the taskbar.
- 2 Drag and drop each window into the appropriate grid.

### 3 Enjoy the convenience of a well-organized desktop.

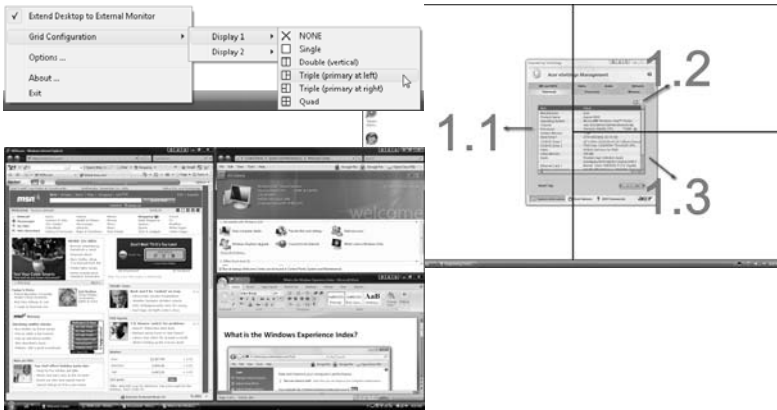

**Note:** Please ensure that the resolution setting of your second monitor is set to the manufacturer's recommended value.



# Frequently asked questions

The following is a list of possible situations that may arise during the use of your computer. Easy solutions are provided for each one.

## I turned on the power, but the computer does not start or boot up.

Look at the power indicator:

- If it is not lit, no power is being supplied to the computer. Check the following:
  - If you are using on the battery, it may be low and unable to power the computer. Connect the AC adapter to recharge the battery pack.
  - Make sure that the AC adapter is properly plugged into the computer and to the power outlet.
- If it is lit, check the following:
  - Is a non-bootable (non-system) disk in the external USB floppy drive? Remove or replace it with a system disk and press **<Ctrl> + <Alt> + <Del>** to restart the system.

## Nothing appears on the screen.

The computer's power management system automatically blanks the screen to save power. Press any key to turn the display back on.

If pressing a key does not turn the display back on, three things might be the cause:

- The brightness level might be too low. Press **<Fn> + <→>** (increase) to adjust the brightness level.
- The display device might be set to an external monitor. Press the display toggle hotkey **<Fn> + <F5>** to toggle the display back to the computer.
- If the Sleep indicator is lit, the computer is in Sleep mode. Press and release the power button to resume.

## No audio is heard from the computer.

Check the following:

- The volume may be muted. In Windows, look at the volume control (speaker) icon on the taskbar. If it is crossed-out, click on the icon and deselect the **Mute all** option.
- The volume level may be too low. In Windows, look at the volume control icon on the taskbar. You can also use the volume control buttons to adjust the volume. See **"Hotkeys" on page 22** for more detail.

- If headphones, earphones or external speakers are connected to the line-out port on the computer, the internal speakers automatically turn off.

### I want to eject the optical drive tray without turning on the power.

There is a mechanical eject hole on the optical drive. Simply insert the tip of a pen or paperclip into the hole and push to eject the tray.

### The keyboard does not respond.

Try attaching an external keyboard to a USB port on the computer. If it works, contact your dealer or an authorized service center as the internal keyboard cable may be loose.

### The printer does not work.

Check the following:

- Make sure that the printer is connected to a power outlet and that it is turned on.
- Make sure that the printer cable is connected securely to the computer's parallel port or a USB port and the corresponding port on the printer.

### I want to set up my location to use the internal modem.

To properly use your communication software, you need to set up your location:

- 1 Click on **Start, Control Panel**.
- 2 Double-click on **Phone and Modem Options**.
- 3 Begin setting up your location.

Refer to the Windows manual.



.....

**Note:** Please note, on first booting your notebook, that you can skip the Internet Connection setup, as it is not necessary to complete the installation of your Operating System. After the Operating System is set up, you can proceed with the Internet Connection setup.

I want to restore my computer to its original settings without recovery CDs.



.....  
**Note:** If your system is the multilingual version, the operating system and language you choose when you first turn on the system will be the only option for future recovery operations.

This recovery process helps you restore the C: drive with the original software content that is installed when you purchase your notebook. Follow the steps below to rebuild your C: drive. (Your C: drive will be reformatted and all data will be erased.) It is important to back up all data files before using this option.

Before performing a restore operation, please check the BIOS settings.

- 1 Check to see if **Acer disk-to-disk recovery** is enabled or not.
- 2 Make sure the **D2D Recovery** setting in **Main** is **Enabled**.
- 3 Exit the BIOS utility and save changes. The system will reboot.



.....  
**Note:** To activate the BIOS utility, press <F2> during POST.

To start the recovery process:

- 1 Restart the system.
- 2 While the Acer logo is showing, press <Alt> + <F10> at the same time to enter the recovery process.
- 3 Refer to the onscreen instructions to perform system recovery.



.....  
**Important!** This feature occupies 15 GB in a hidden partition on your hard disk

## Requesting service

### International Travelers Warranty (ITW)

Your computer is backed by an International Travelers Warranty (ITW) that gives you security and peace of mind when traveling. Our worldwide network of service centers are there to give you a helping hand.

An ITW passport comes with your computer. This passport contains all you need to know about the ITW program. A list of available, authorized service centers is in this handy booklet. Read this passport thoroughly.

Always have your ITW passport on hand, especially when you travel, to receive the benefits from our support centers. Place your proof-of-purchase in the flap located inside the front cover of the ITW passport.

If the country you are traveling in does not have an Acer-authorized ITW service site, you can still get in contact with our offices worldwide. Please consult <http://global.acer.com>.

### Before you call

Please have the following information available when you call Acer for online service, and please be at your computer when you call. With your support, we can reduce the amount of time a call takes and help solve your problems efficiently. If there are error messages or beeps reported by your computer, write them down as they appear on the screen (or the number and sequence in the case of beeps).

You are required to provide the following information:

Name: \_\_\_\_\_

Address: \_\_\_\_\_

Telephone number: \_\_\_\_\_

Machine and model type: \_\_\_\_\_

Serial number: \_\_\_\_\_

Date of purchase: \_\_\_\_\_

# Battery pack

The computer uses a battery pack that gives you long use between charges.

## Battery pack characteristics

The battery pack has the following characteristics:

- Employs current battery technology standards.
- Delivers a battery-low warning.

The battery is recharged whenever you connect the computer to the AC adapter. Your computer supports charge-in-use, enabling you to recharge the battery while you continue to operate the computer. However, recharging with the computer turned off results in a significantly faster charge time.

The battery will come in handy when you travel or during a power failure. It is advisable to have an extra fully charged battery pack available as backup. Contact your dealer for details on ordering a spare battery pack.

## Maximizing the battery's life

Like all other batteries, your computer's battery will degrade over time. This means that the battery's performance will diminish with time and use. To maximize your battery's life, you are advised to adhere to the recommendations set out below.

## Conditioning a new battery pack

Before you use a battery pack for the first time, there is a "conditioning" process that you should follow:

- 1 Insert the new battery without turning the computer on.
- 2 Connect the AC adapter and fully charge the battery.
- 3 Disconnect the AC adapter.
- 4 Turn on the computer and operate using battery power.
- 5 Fully deplete the battery until the battery-low warning appears.
- 6 Reconnect the AC adapter and fully charge the battery again.

Follow these steps again until the battery has been charged and discharged three times.

Use this conditioning process for all new batteries, or if a battery hasn't been used for a long time. If the computer is to be stored for more than two weeks, you are advised to remove the battery pack from the unit.



.....

**Warning:** Do not expose battery packs to temperatures below 0°C (32°F) or above 45°C (113°F). Extreme temperatures may adversely affect the battery pack.

By following the battery conditioning process you condition your battery to accept the maximum possible charge. Failure to follow this procedure will prevent you from obtaining the maximum battery charge, and will also shorten the effective lifespan of the battery.

In addition, the useful lifespan of the battery is adversely affected by the following usage patterns:

- Using the computer on constant AC power with the battery inserted. If you want to use constant AC power, you are advised to remove the battery pack after it is fully charged.
- Not discharging and recharging the battery to its extremes, as described above.
- Frequent use; the more you use the battery, the faster it will reach the end of its effective life. A standard computer battery has a life span of about 300 charges.

## Installing and removing the battery pack



.....

**Important!** Before removing the battery from the unit, connect the AC adapter if you want to continue using your computer. Otherwise, turn off the computer first.

To install a battery pack:

- 1 Align the battery with the open battery bay; make sure that the end with the contacts will enter first, and that the top surface of the battery is facing up.
- 2 Slide the battery into the battery bay and gently push until the battery locks in place.

To remove a battery pack:

- 1 Slide the battery release latch to release the battery.
- 2 Pull the battery from the battery bay.

## Charging the battery

To charge the battery, first make sure that it is correctly installed in the battery bay. Plug the AC adapter into the computer, and connect to a mains power outlet. You can continue to operate your computer on AC power while your battery is charging. However, charging the battery with the computer turned off results in a significantly faster charge time.



.....  
**Note:** You are advised to charge the battery before retiring for the day. Charging the battery overnight before traveling enables you to start the next day with a fully charged battery.

## Checking the battery level

The Windows power meter indicates the current battery level. Rest the cursor over the battery/power icon on the taskbar to see the battery's present charge level.

## Optimising battery life

Optimizing battery life helps you get the most out of battery operation, prolonging the charge/recharge cycle and improving recharging efficiency. You are advised to follow the suggestions set out below:

- Purchase an extra battery pack.
- Use AC power whenever possible, reserving battery for on-the-go use.
- Eject a PC Card if it is not being used, as it will continue to draw power (for selected model).
- Store the battery pack in a cool, dry place. The recommended temperature is 10°C (50°F) to 30°C (86°F). Higher temperatures cause the battery to self-discharge faster.
- Excessive recharging decreases the battery life.
- Look after your AC adapter and battery.

## Battery-low warning

When using battery power pay attention to the Windows power meter.



**Warning:** Connect the AC adapter as soon as possible after the battery-low warning appears. Data will be lost if the battery to become fully depleted and the computer shuts down.

When the battery-low warning appears, the recommended course of action depends on your situation:

Situation	Recommended Action
The AC adapter and a power outlet are available.	<ol style="list-style-type: none"> <li>1. Plug the AC adapter into the computer, and then connect to the mains power supply.</li> <li>2. Save all necessary files.</li> <li>3. Resume work.</li> </ol> <p><b>Turn off the computer if you want to recharge the battery rapidly.</b></p>
An extra fully charged battery pack is available.	<ol style="list-style-type: none"> <li>1. Save all necessary files.</li> <li>2. Close all applications.</li> <li>3. Shut down the operating system to turn off the computer.</li> <li>4. Replace the battery pack.</li> <li>5. Turn on the computer and resume work.</li> </ol>
The AC adapter or a power outlet is unavailable. You have no spare battery pack.	<ol style="list-style-type: none"> <li>1. Save all necessary files.</li> <li>2. Close all applications.</li> <li>3. Shut down the operating system to turn off the computer.</li> </ol>



# Acer Arcade Deluxe

Acer Arcade Deluxe is an integrated player for music, photos, DVD movies and videos. Use the MediaConsole, touchpad or arrow keys to select the media type you wish to enjoy.

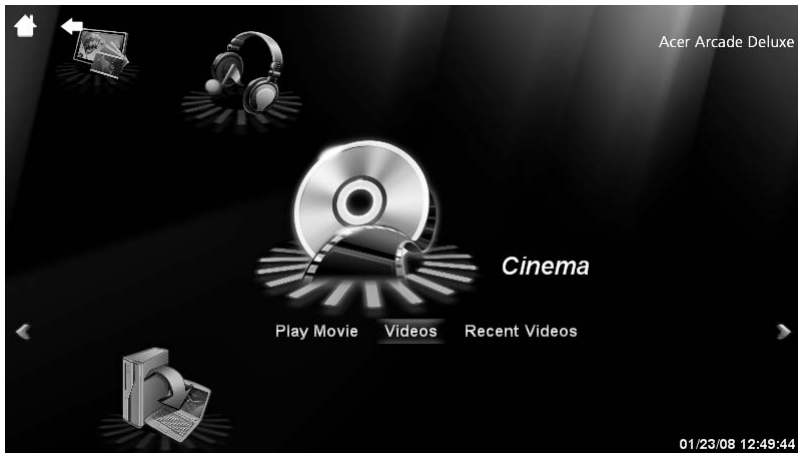

- **Cinema** — watch DVDs, VCDs or Blu-Ray movies, and video clips
- **Homemedia** — connect to other devices wirelessly to share media content
- **Advanced** — change settings, update your Arcade software, view the help file and About information
- **Albums** — view photos stored on your hard disk or removable media
- **Music** — listen to music files in a variety of formats



.....

**Note:** While watching videos, optical discs or slideshows, your screensaver and power-saving features are unavailable.



.....

**Note:** For more detailed information on the features of Acer Arcade, please refer to the Arcade Help menu. This can be accessed from the Arcade home page by selecting **Help**.

## General controls

When watching video clips, movies or slideshows using full-screen resolution, two pop-up control panels are shown when you move the pointer. They automatically disappear after several seconds. The Navigation Controls panel

appears at the top and the Player Controls panel appears at the bottom of the screen.

## Navigation controls

To return to the Arcade home page, click the **Home** button in the upper-left corner of the window. To go up one folder level while searching for content, click the **arrow**. The buttons in the upper right (minimize, maximize, close) have standard PC behaviors.

To quit Arcade, click the **Close** button in the upper right corner of the window.

## Player controls

At the bottom of the window, the player controls — used for video, slideshows, movies and music — are shown. They provide standard playback controls (play, pause, stop, etc.) and volume controls (mute and volume up/down).



**Note:** When playing movies from optical discs, there are additional controls added to the right of the volume controls. These are discussed in more detail in the Cinema of this guide.

## Cinema

### Movies:

Click **Movies** to watch a movie from your optical disc drive. Depending in the type of optical drive installed in your computer, you can play movies from Blu-Ray discs, standard DVDs and video CDs (VCDs) with the Cinema function of Acer Arcade Deluxe. This player has the features and controls of a typical DVD player.

When you insert a disk into the DVD drive, the movie begins playing automatically. To control the movie, the pop-up player control panel appears at the bottom of the window when you move the pointer.

If more than one optical drive contains a playable disc, you will be asked to select which one you would like to watch when you click **Play Movie**.

Alternatively, you can select content stored on your HDD by clicking **Videos** and navigating to the video clip you wish to view using a folder browser.

When viewing DVDs, the following special controls are added to the pop-up panel:

- DVD Menu
- Subtitles
- Language
- Snapshot

- Angle

If you move your mouse/cursor while you're watching a movie, a menu bar will appear at the bottom of the screen. This contains buttons to control the movie playback, select subtitles, adjust volume, select soundtrack language and set advanced features.



.....

Function availability will depend on what the optical disc being played supports.

Clicking the stop button will stop the movie playback, and return you to the Cinema main screen. At the bottom of the screen are buttons that allow you to resume the movie from the point it was stopped, restart the movie from the beginning or eject the disk.

## Videos:

Click **Videos** to watch a video clip stored on your hard drive.



.....

Note: The Video feature is designed to play back many different kinds of video formats. Refer to the Video help section for a full list of compatible formats. If you want to watch a DVD or VCD, use **Cinema**.

### Playing a video file:

Click **Videos** to open a file browser to navigate to the video clip you want to view.

To play a video file, double-click on it. The video will play at full screen. The pop-up control panel will appear at the bottom of the screen when you move the mouse. To return to the Video page, click **Stop**.

You can capture a still of a scene by clicking the **Snapshot** button in the pop-up control panel.

## Recent Videos:

Shows video clips saved recently. Double-click on a clip to watch it.

## HomeMedia

HomeMedia is a program that lets you access and share media files and TV signals via your home network. HomeMedia gives you access to your network computers with Media Server and TV Server installed, so you can view shared music, videos, pictures and TV signals.

Click **HomeMedia** to open the main page that displays a list of the media and TV servers available on your network. HomeMedia is compatible with most UPnP client devices. Click **Refresh** at any time to search for newly shared media servers.



.....

**Note:** You must first install and setup Media Server to share media files and TV Server to share TV signals.



.....

You will need to have your wireless adaptor active before you can use HomeMedia.

## Advanced

This section contains the settings in Acer Arcade Deluxe that allow you to fine-tune its performance to suit your machine and your personal preferences.

### Live Update:

Click **Live Update** to connect to the Internet to check for, and download, available updates to the software.

### Settings:

Click **Settings** to make various adjustments to your Acer Arcade Deluxe. Here, you will be able to modify Display, Audio, Photo, DVD and BD settings to get the best out of your computer.

#### Display:

Use this section to set the display type. You can choose the Display Output and Color Profile to suit your environment and preferences.

Under Display Output, you can select from CinemaVision, Letterbox or Pan & Scan:

- The Letterbox option displays widescreen movie content in its original aspect ratio and adds black bars at the top and bottom of the screen.
- Acer CinemaVision is a nonlinear video stretching technology that produces minimal distortion in the center of the picture.

- **Pan & Scan** displays the central portion of DVD titles in widescreen ratio, and allows you to drag the display area to view different portions of the video.

#### Audio:

Use **Speaker Environment** to choose between **Headphones**, **SPDIF**, **2 Speakers** or more speakers depending on your audio equipment.

Output Mode should be set to Stereo if you are using speakers, Dolby Surround, or Virtual Surround Sound if you are using headphones. You can select from a variety of Virtual Surround Sound settings to create the effects of different venues.



.....

**Note:** If your speakers are not capable of outputting low-frequency signals, it is recommended that you do not select **Virtual Surround Sound**, in order to avoid damaging your speakers.

**Audio Channel Expander** should be used for better 4- or 6-speaker output.

**Dynamic Range Compression** can compensate for different listening environments for enhanced audio enjoyment.

#### Photo:

Use this page to set preferences for your slideshow when viewing photos.

#### DVD:

Acer Arcade Deluxe has several features and technologies to extend battery life while watching DVD movies. On this page, you can select whether you wish to turn the features off or not.



.....

Turning on **Extend Playback Time**, will result in a small loss of playback performance.

#### BD:

From this page, you can set the **Network Speed** for downloading online Blu-ray Disc content. You can also set the **Region Code**.



.....

**Region Code** can be changed a maximum of five (5) times.

In each of the above sections, you can click **Default** to return the Acer Arcade Deluxe settings to their default values

## Help:

Click **Help** to view the Help file for detailed information on using Acer Arcade Deluxe.

## About:

Click **About** to view the copyright and vendor information for Acer Arcade Deluxe.

## Albums

Acer Arcade Deluxe lets you view digital photos individually or as a slideshow, from any available drive on your computer. Click **Albums** to open the main page.



Click **Photos** to open a folder browser that shows both individual pictures and folders. **Click** on a folder to open it.

To view a slideshow, open the folder containing the pictures you wish to view, select all or some of the pictures and click **Menu > Slideshow**. The slideshow is played at fullscreen resolution. Use the pop-up control panel to control the slideshow.

You can also view a single picture by clicking on it. This opens the picture at fullscreen resolution.

You can then use the onscreen controls to zoom in and out, and to pan in four directions.

## Editing Pictures

Choose **Menu** and you can Rotate, Remove Red Eye, and Auto Fix (optimize the brightness and contrast) pictures to improve the appearance of your images.

## Slideshow settings

To change slideshow settings refer to the Arcade section above.

## Snapshot

Snapshot mode is available in Cinema mode. This function can be used to capture the onscreen image at any time.

A single frame image will be captured and stored in a user-designated directory. The destination directory can be changed from the "Settings" menu.



.....

**Note:** For more details on editing video and all the associated features, please refer to the Acer Arcade help menu.

## Music

For convenient access to your music collection, click **Music** to open the Music homepage.

Select the folder, CD or category that contains the music you want to listen to. Click **Play** to listen to the entire content from the beginning, or select the song that you want to hear from the list.

The songs in the folder are shown as a list with album information at the top of the page, while the toolbar at the bottom of the page has controls for **Play**, **Shuffle**, **Repeat All**, **Visualize** volume and **Menu**. Visualize allows you to watch computer-generated visuals while you listen to music.

## Background mode

With Acer Arcade you can continue listening to music while you perform certain other functions. Press the onscreen **Stop** button to stop the playback at anytime.

# Taking your notebook PC with you

This section gives you tips and hints to consider when moving around or traveling with your computer.

## Disconnecting from the desktop

Follow these steps to disconnect your computer from external accessories:

- 1 Save any open files.
- 2 Remove any media, floppy disks or compact disks from the drive(s).
- 3 Shut down the computer.
- 4 Close the display cover.
- 5 Disconnect the cord from the AC adapter.
- 6 Disconnect the keyboard, pointing device, printer, external monitor and other external devices.
- 7 Disconnect the Kensington lock if you are using one to secure the computer.

## Moving around

When you are just moving within short distances, for example, from your office desk to a meeting room.

## Preparing the computer

Before moving the computer, close and latch the display cover to place it in Sleep mode. You can now safely take the computer anywhere you go within the building. To bring the computer out of Sleep mode, open the display; then press and release the power button.

If you are taking the computer to a client's office or a different building, you may choose to shut down the computer:

Click on **Start**, **Turn Off Computer**, then click on **Turn Off** (Windows XP).

Or:

You can put the computer in Sleep mode by pressing **<Fn> + <F4>**. Then close and latch the display.

When you are ready to use the computer again, unlatch and open the display; then press and release the power button.





.....

**Note:** If the Sleep indicator is off, the computer has entered Hibernation mode and is turned off. If the power indicator is off but the Sleep indicator is on, the computer has entered Sleep mode. In both cases, press and release the power button to turn the computer back on. Note that the computer may enter Hibernation mode after being in Sleep mode for a period of time.

## What to bring to meetings

If your meeting is relatively short, you probably do not need to bring anything with you other than your computer. If your meeting will be longer, or if your battery is not fully charged, you may want to bring the AC adapter with you to plug in your computer in the meeting room.

If the meeting room does not have an electrical outlet, reduce the drain on the battery by putting the computer in Sleep mode. Press **<Fn> + <F4>** or close the display cover whenever you are not actively using the computer. To resume, open the display (if closed), then press and release the power button.

## Taking the computer home

When you are moving from your office to your home or vice versa.

## Preparing the computer

After disconnecting the computer from your desktop, follow these steps to prepare the computer for the trip home:

- Check that you have removed all media and compact disks from the drive(s). Failure to remove the media can damage the drive head.
- Pack the computer in a protective case that can prevent the computer from sliding around and cushion it if it should fall.



.....

**Caution:** Avoid packing items next to the top cover of the computer. Pressure against the top cover can damage the screen.

## What to take with you

Unless you have some items at home, take the following items with you:

- AC adapter and power cord
- The printed User's Guide

## Special considerations

Follow these guidelines to protect your computer while traveling to and from work:

- Minimize the effects of temperature changes by keeping the computer with you.
- If you need to stop for an extended period of time and cannot carry the computer with you, leave the computer in the trunk of the car to avoid exposing the computer to excessive heat.
- Changes in temperature and humidity can cause condensation. Allow the computer to return to room temperature, and inspect the screen for condensation before turning on the computer. If the temperature change is greater than 10 °C (18 °F), allow the computer to come to room temperature slowly. If possible, leave the computer for 30 minutes in an environment with a temperature between outside and room temperature.

## Setting up a home office

If you frequently work on your computer at home, you may want to purchase a second AC adapter for use at home. With a second AC adapter, you can avoid carrying the extra weight to and from home.

If you use your computer at home for significant periods of time, you might also want to add an external keyboard, monitor or mouse.

## Traveling with the computer

When you are moving within a larger distance, for instance, from your office building to a client's office building or traveling locally.

## Preparing the computer

Prepare the computer as if you were taking it home. Make sure that the battery in the computer is charged. Airport security may require you to turn on your computer when carrying it into the gate area.

## What to take with you

Take the following items with you:

- AC adapter
- Spare, fully-charged battery pack(s)
- Additional printer driver files if you plan to use another printer

## Special considerations

In addition to the guidelines for taking the computer home, follow these guidelines to protect your computer while traveling:

- Always take the computer as carry-on luggage.
- If possible, have the computer inspected by hand. Airport security X-ray machines are safe, but do not put the computer through a metal detector.
- Avoid exposing floppy disks to hand-held metal detectors.

## Traveling internationally with the computer

When you are moving from country to country.

### Preparing the computer

Prepare the computer as you would normally prepare it for traveling.

### What to bring with you

Bring the following items with you:

- AC adapter
- Power cords that are appropriate for the country to which you are traveling
- Spare, fully-charged battery packs
- Additional printer driver files if you plan to use another printer
- Proof of purchase, in case you need to show it to customs officials
- International Travelers Warranty passport

## Special considerations

Follow the same special considerations as when traveling with the computer. In addition, these tips are useful when traveling internationally:

- When traveling in another country, check that the local AC voltage and the AC adapter power cord specifications are compatible. If not, purchase a power cord that is compatible with the local AC voltage. Do not use converter kits sold for appliances to power the computer.
- If you are using the modem, check if the modem and connector is compatible with the telecommunications system of the country you are traveling in.

# Securing your computer

Your computer is a valuable investment that you need to take care of. Learn how to protect and take care of your computer.

Security features include hardware and software locks — a security notch and passwords.

## Using a computer security lock

The notebook comes with a Kensington-compatible security slot for a security lock.

Wrap a computer security lock cable around an immovable object such as a table or handle of a locked drawer. Insert the lock into the notch and turn the key to secure the lock. Some keyless models are also available.

## Using passwords

Passwords protect your computer from unauthorized access. Setting these passwords creates several different levels of protection for your computer and data:

- Supervisor Password prevents unauthorized entry into the BIOS utility. Once set, you must enter this password to gain access to the BIOS utility. See **"BIOS utility" on page 59**.
- User Password secures your computer against unauthorized use. Combine the use of this password with password checkpoints on boot-up and resume from Hibernation for maximum security.
- Password on Boot secures your computer against unauthorized use. Combine the use of this password with password checkpoints on boot-up and resume from Hibernation for maximum security.



**Important!** Do not forget your Supervisor Password! If you forget your password, please get in touch with your dealer or an authorized service center.

## Entering passwords

When a password is set, a password prompt appears in the center of the display screen.

- When the Supervisor Password is set, a prompt appears when you press <F2> to enter the BIOS utility at boot-up.
- Type the Supervisor Password and press <Enter> to access the BIOS utility. If you enter the password incorrectly, a warning message appears. Try again and press <Enter>.
- When the User Password is set and the password on boot parameter is enabled, a prompt appears at boot-up.
- Type the User Password and press <Enter> to use the computer. If you enter the password incorrectly, a warning message appears. Try again and press <Enter>.



**Important!** You have three chances to enter a password. If you fail to enter the password correctly after three tries, the system halts. Press and hold the power button for four seconds to shut down the computer. Then turn on the computer again, and try again.

## Setting passwords

You can set passwords using the BIOS utility.

# Expanding through options

Your notebook PC offers you a complete mobile computing experience.

## Connectivity options

Ports allow you to connect peripheral devices to your computer as you would with a desktop PC. For instructions on how to connect different external devices to the computer, read the following section.

### Fax/data modem

Your computer has a built-in V.92 56 Kbps fax/data modem.



.....  
**Warning! This modem port is not compatible with digital phone lines. Plugging this modem into a digital phone line will damage the modem.**

To use the fax/data modem port, connect a phone cable from the modem port to a telephone jack.

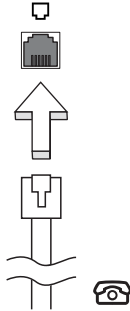

.....  
**Warning! Please make sure that the cable you use is appropriate for the country in which you are working.**

## Built-in network feature

The built-in network feature allows you to connect your computer to an Ethernet-based network.

To use the network feature, connect an Ethernet cable from the Ethernet (RJ-45) port on the chassis of the computer to a network jack or hub on your network.

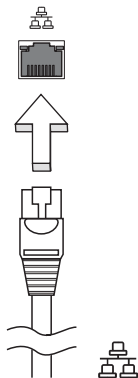

## Consumer Infrared (CIR) (only for certain models)

The computer's Consumer Infrared (CIR) port is used to receive signals from your remote control, or other devices with CIR capability.

## Universal Serial Bus (USB)

The USB 2.0 port is a high-speed serial bus which allows you to connect USB peripherals without taking up precious system resources.

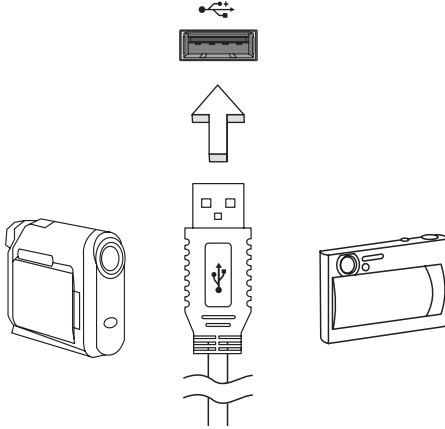

## IEEE 1394 port (only for certain models)

The computer's IEEE 1394 port allows you to connect to an IEEE 1394-compatible device like a video camera or digital camera. See your video or digital camera's documentation for details.

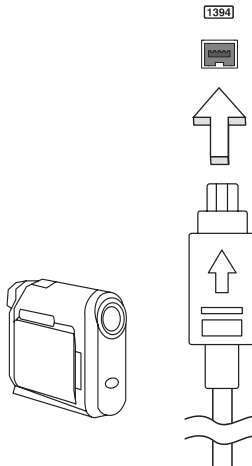



## High-Definition Multimedia Interface (only for certain models)

HDMI (High-Definition Multimedia Interface) is an industry-supported, uncompressed, all-digital audio/video interface. HDMI provides an interface between any compatible digital audio/video source, such as a set-top box, DVD player, and A/V receiver and a compatible digital audio and/or video monitor, such as a digital television (DTV), over a single cable.

Use the HDMI port on your computer to connect with high-end audio and video equipment. Single cable implementation allows tidy setup and fast connection.



## ExpressCard

The ExpressCard is the newest version of the PC Card. It is a smaller and faster interface that further enhances the usability and expandability of your computer.

ExpressCards support a vast number of expansion options, including flash memory card adapters, TV-tuners, Bluetooth connectivity and IEEE 1394B adapters. ExpressCards support USB 2.0 and PCI Express applications.



**Important!** There are two types, ExpressCard/54 and ExpressCard/34 (54mm and 34mm), each with different functions. Not all ExpressCard slots will support both types. Please refer to your card's manual for details on how to install and use the card, and its functions.

## Inserting an ExpressCard

Insert the card into the slot and push gently until it clicks into position.

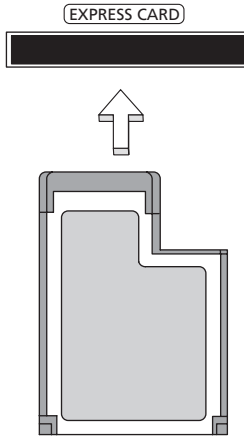

## Ejecting an ExpressCard

Before ejecting an ExpressCard:

- 1 Exit the application using the card.
- 2 Left-click on the remove hardware icon on the taskbar and stop the card operation.
- 3 Push the card gently into the slot and release to pop out the card. Then pull the card free from the slot.

## Installing memory

Follow these steps to install memory:

- 1 Turn off the computer, unplug the AC adapter (if connected) and remove the battery pack. Then turn the computer over to access its base.
- 2 Remove the screws from the memory cover; then lift up and remove the memory cover.

- 3 (a) Insert the memory module diagonally into the slot, then (b) gently press it down until it clicks into place.

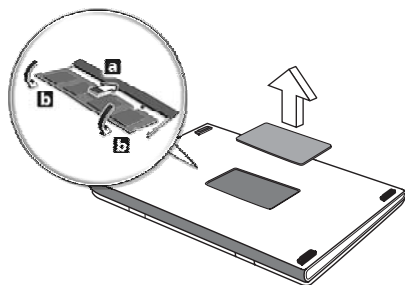

- 4 Replace the memory cover and secure it with the screw.
- 5 Reinstall the battery pack, and reconnect the AC adapter.
- 6 Turn on the computer.

The computer automatically detects and reconfigures the total memory size. Please consult a qualified technician or contact your local Acer dealer.

## Connecting your TV and AV-in cables (only for certain models)

Follow the instructions below to set up the TV function of your Acer notebook.

### PAL/SECAM and NTSC systems

- 1 Plug the PAL/SECAM cable's RF plug into your notebook's RF-in jack.
- 2 Connect the other end to your TV antenna cable, using the NTSC converter if necessary.

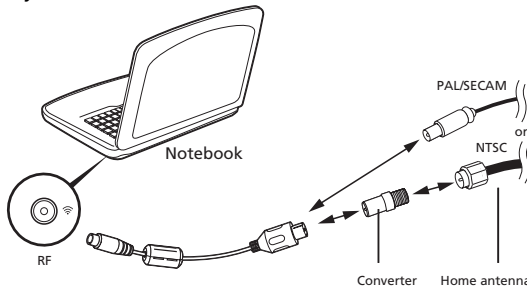

**Important!** Please ensure you use the correct cable system for your region before attempting to connect the antenna cable.

### Acer DVB-T digital antenna

To connect the antenna:

Plug the antenna cable into the RF-in jack of your notebook.

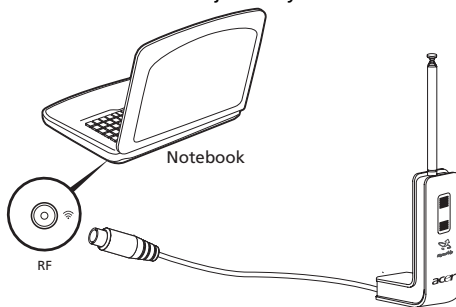

**Note:** All diagrams are for reference purposes only. Actual equipment may differ in appearance.

### To set up the antenna:

- 1 Push gently at the top until the bottom section pops out.
- 2 Pull the bottom up until it is positioned at 90 degrees to the antenna body.

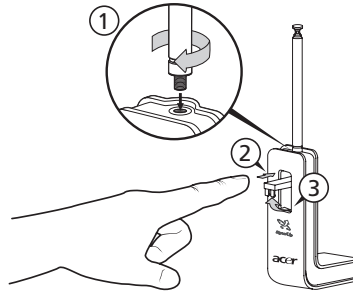

- 3 To ensure good reception, the antenna can be positioned on top of your notebook display using the special clip, as shown below.
- 4 Extend the antenna to improve the quality of the reception.

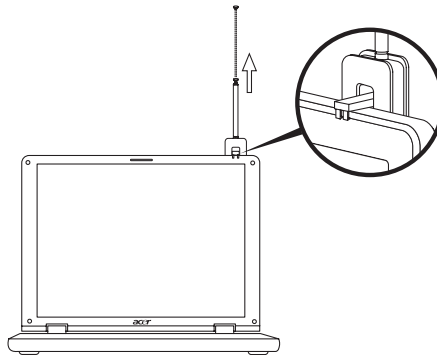

**Note:** The antenna is only compatible with DVB-T digital TV systems.

A magnet located on the base of the antenna unit also allows you to fix it firmly onto a metal surface for better stability and reception.



**Warning!** Do not place the magnet near the hard disk drive of your computer. Doing so may damage the drive and/or data.

## AV-in cable

The AV-in cable can be used to connect your notebook to a VHS player or camcorder for viewing, capturing and recording video clips.

- 1 Plug the single end of the cable into the AV-in port of your notebook.
- 2 Connect the other ends to the S-video or composite audio/video jacks on your VHS player, camcorder or other compatible device.

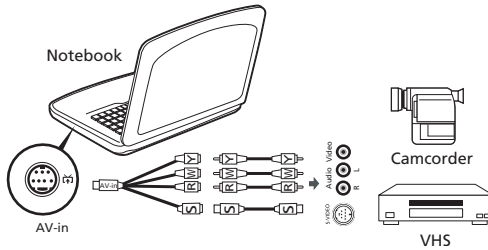

**Note:** Extension cables may not be necessary. For more details on how to capture TV or video clips please refer to the help file.

## BIOS utility

The BIOS utility is a hardware configuration program built into your computer's BIOS.

Your computer is already properly configured and optimized, and you do not need to run this utility. However, if you encounter configuration problems, you may need to run it.

To activate the BIOS utility, press <F2> during the POST; while the notebook PC logo is being displayed.

## Boot sequence

To set the boot sequence in the BIOS utility, activate the BIOS utility, then select **Boot** from the categories listed at the top of the screen.

## Enable disk-to-disk recovery

To enable disk-to-disk recovery (hard disk recovery), activate the BIOS utility, then select **Main** from the categories listed at the top of the screen. Find **D2D Recovery** at the bottom of the screen and use the <F5> and <F6> keys to set this value to **Enabled**.

## Password

To set a password on boot, activate the BIOS utility, then select **Security** from the categories listed at the top of the screen. Find **Password on boot:** and use the <F5> and <F6> keys to enable this feature.

## Using software

### Playing DVD movies

When the DVD drive module is installed in the optical drive bay, you can play DVD movies on your computer.

- 1 Eject the DVD disk.



**Important!** When you launch the DVD player for the first time, the program asks you to enter the region code. DVD disks are divided into 6 regions. Once your DVD drive is set to a region code, it will play DVD disks of that region only. You can set the region code a maximum of five times (including the first time), after which the last region code set will remain permanent. Recovering your hard disk does not reset the number of times the region code has been set. Refer to the table below for DVD movie region code information.

- 2 The DVD movie will automatically play after a few seconds.

Region code	Country or region
1	USA, Canada
2	Europe, Middle East, South Africa, Japan
3	Southeast Asia, Taiwan, South Korea
4	Latin America, Australia, New Zealand
5	Former USSR, parts of Africa, India
6	People's Republic of China



**Note:** To change the region code, insert a DVD movie of a different region into the DVD drive. Please refer to the online help for more information.



# Power management

This computer has a built-in power management unit that monitors system activity. System activity refers to any activity involving one or more of the following devices: keyboard, mouse, hard disk, peripherals connected to the computer, and video memory. If no activity is detected for a period of time (called an inactivity timeout), the computer stops some or all of these devices in order to conserve energy.

This computer employs a power management scheme that supports the advanced configuration and power interface (ACPI), which allows for maximum power conservation and maximum performance at the same time. Windows handles all power-saving chores for your computer.

# Acer eRecovery Management

Acer eRecovery Management is a tool to quickly back up and restore the system. You can create and save a backup of the entire C:\ drive to a hard disk, CDs or DVDs. You can also back up/restore the factory default image, and reinstall applications and drivers.



-----

**Note:** All of the following content is for general reference only. Actual product specifications may vary.

Acer eRecovery Management consists of the following functions:

1 Backup:

- Back up factory default to CD/DVD
- Back up drivers and applications to CD/DVD
- Create user backup
- Manage user backups

2 Restore:

- Restore system to factory default
- Reinstall applications/drivers
- Restore system from user backup
- Password settings

This chapter will guide you through each process.



-----

**Note:** This feature is only available on certain models. For systems that do not have a built-in optical disc burner, plug in an external optical disc burner before entering Acer eRecovery Management for optical disc-related tasks.

To use the password protection feature of Acer eRecovery Management, you must first set the Empowering Technology password. The Empowering Technology password is set by launching Acer eRecovery Management and clicking **Password settings** in the **Restore** page.

## Burn backup discs

From the Backup page of Acer eRecovery Management, you can burn the factory default image or back up drivers and applications.

- 1 Select Acer eRecovery Management from the Empowering Technology toolbar to start Acer eRecovery Management.

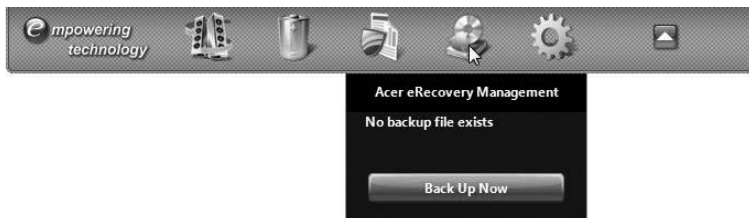

- 2 Acer eRecovery Management opens to the **Backup** page.



- 3 Select the type of backup (factory default or drivers and applications) you would like to burn to disc.
- 4 Follow the instructions on screen to complete the process.



.....

**Note:** Create a factory default image when you want to burn a bootable disc that contains your computer's entire operating system as it was delivered to you from the factory. If you wish to have a disc that will allow you to browse the contents and install selected drivers and applications, create a drivers and application backup instead — this disc will not be bootable.

## Create a user backup

You can easily create full and fast (incremental) backup of the whole C:\ drive to a hard disk or optical discs from the Backup page of Acer eRecovery Management.



.....

**Note:** Fast (incremental) Backup is only available after a Full Backup is made.

- 1 Select Acer eRecovery Management from the Empowering Technology toolbar to start Acer eRecovery Management.
- 2 On the Backup page of Acer eRecovery Management, click **Create user backup**.

- 3 Choose the destination of the backup you are going to create. By default, user-created backups are stored to the D:\ drive.

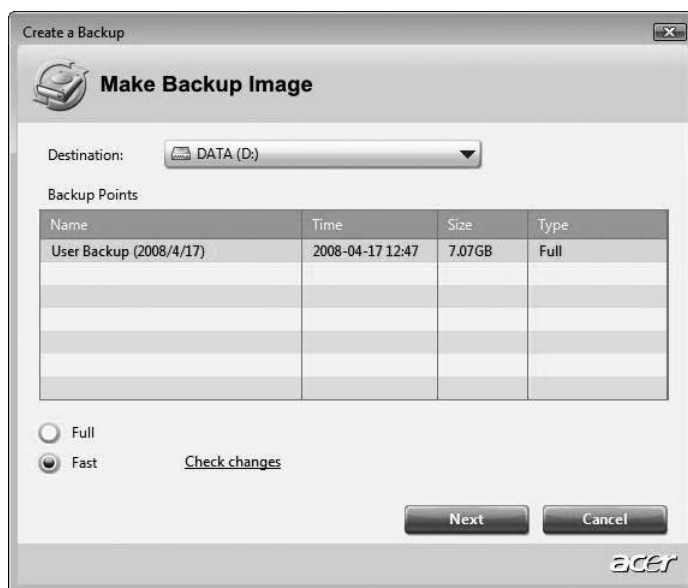

- 4 Select whether you want to create a **Full** or **Fast** backup.
- 5 Follow the instructions on screen to complete the process.

## Manage user backups

You can delete, rename or burn backups to disc from this page.

- 1 Select Acer eRecovery Management from the Empowering Technology toolbar to start Acer eRecovery Management.
- 2 On the Backup page of Acer eRecovery Management, click **Manage user backups**.
- 3 Select the user backup file you want to **Delete, Rename** or **Burn disc**.

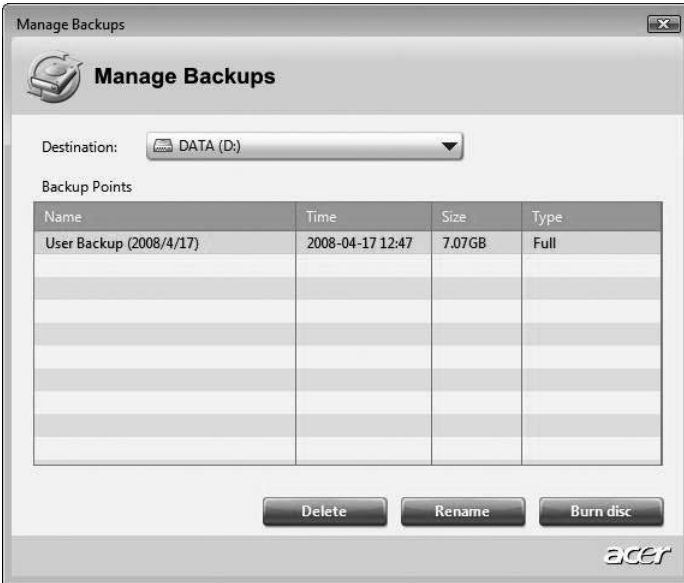

- 4 Select the action you want to perform.
- 5 Follow the instructions on screen to complete the process.

## Restore

The restore feature allows you to restore or recover the system from a factory default image, from a user-created image, or from previously created CD and DVD backups. You can also reinstall applications and drivers for your Acer system.

- 1 Select Acer eRecovery Management from the Empowering Technology toolbar to start Acer eRecovery Management.
- 2 Switch to the restore page by selecting the **Restore** button.



- 3 You can choose to restore the system from a factory default image, restore from a previously created user backup or reinstall applications and drivers. If you choose to restore from a user-created backup, you will need to select the backup point you would like to restore from.
- 4 Follow the instructions on screen to complete the process.

## Restore Windows Vista from backup discs

To restore Windows Vista from your previously burned backup discs, you will need to insert the first backup disc and enable the **F12 Boot Menu** via the BIOS Setup Utility.

- 1 Turn on your computer and insert the first system recovery disc into the optical disc drive. Restart your computer.
- 2 During startup when the Acer logo shows, press the **F2** key to enter **BIOS Setup**, where you can set system parameters.
- 3 Use the left and right arrow keys to select the **Main** submenu.
- 4 Use the up and down arrow keys to select **F12 Boot Menu**

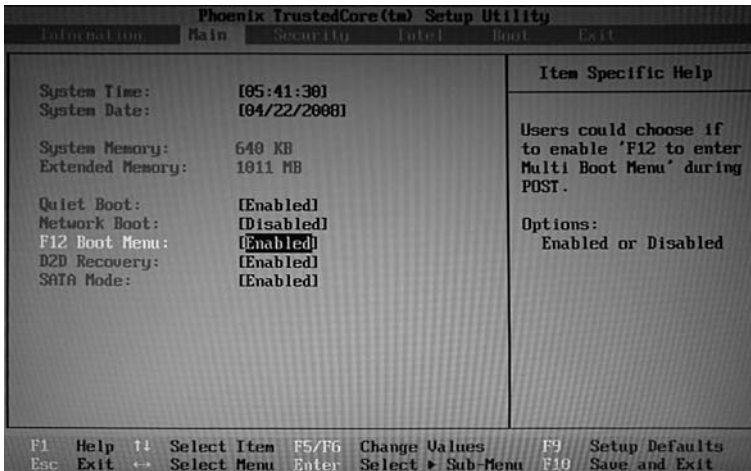

- 5 Use the **F5** or **F6** key to change **F12 Boot Menu** to **Enabled**.
- 6 Press the **ESC** key to enter the **Exit** submenu, press the **ENTER** key to **Exit Saving Changes**. Press the **ENTER** key again to select **Yes**. The system will reboot.



- 7 After rebooting, when the Acer logo shows, press the **F12** key to open the **Boot Menu**. Here you can select which device to boot from.

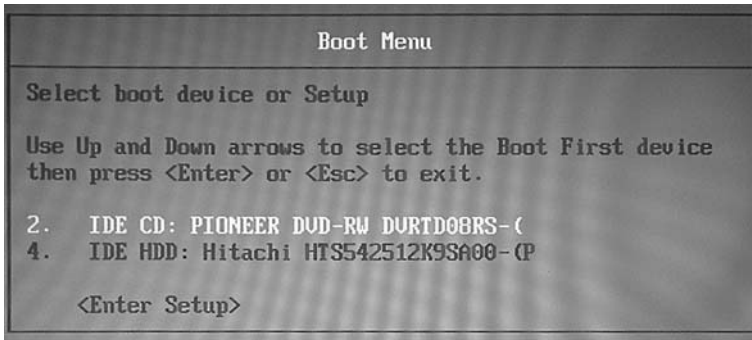

- 8 Use the arrow keys to select the **IDE CD**, then press the **ENTER** key. Windows will be installed from the recovery disc.
- 9 Insert the second recovery disc when prompted, then follow the onscreen prompts to complete the restore.
- 10 Remove the recovery disc from the optical drive once the restore is complete. Do this before rebooting your computer.



.....

**Note:** This feature is only available on certain models.

If you prefer to set the boot priority for long-term use, you should select the **Boot** submenu.

- 1 Turn on your computer and insert the first system recovery disc into the optical disc drive. Restart your computer.
- 2 During startup when the Acer logo shows, press the **F2** key to enter **BIOS Setup**, where you can set system parameters.
- 3 Use the left and right arrow keys to select the **Boot** submenu.

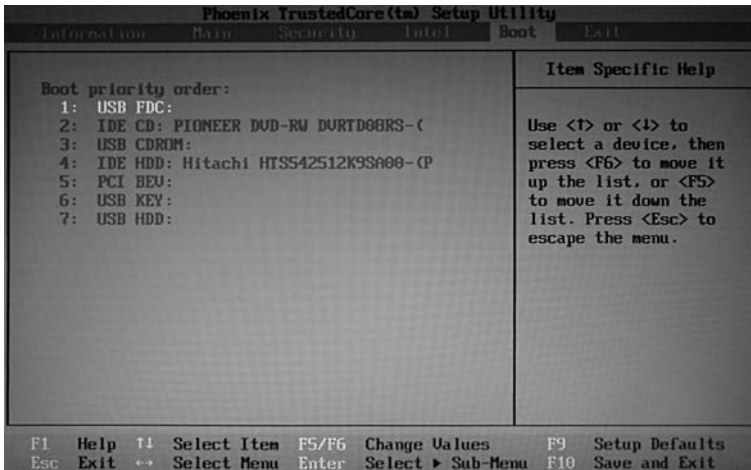

- 4 Use the up and down arrow keys to select the **IDE CD** device.
- 5 Use the **F6** key to move the **IDE CD** device to the highest boot priority, or use the **F5** key to move other devices to a lower boot priority. Ensure that the **IDE CD** device is the highest priority.
- 6 Press the **ESC** key to enter the **Exit** submenu, press the **ENTER** key to **Exit Saving Changes**. Press the **ENTER** key again to select **Yes**. The system will reboot.
- 7 When you reboot, Windows will be installed from the recovery disc.
- 8 Insert the second recovery disc when prompted, then follow the onscreen prompts to complete the restore.
- 9 Remove the recovery disc from the optical drive once the restore is complete. Do this before rebooting your computer.

# Troubleshooting

This chapter shows you how to deal with common system problems. Read it before calling a technician if a problem occurs. Solutions to more serious problems require opening up the computer. Do not attempt to open the computer yourself; contact your dealer or authorized service center for assistance.

## Troubleshooting tips

This notebook PC incorporates an advanced design that delivers onscreen error message reports to help you solve problems.

If the system reports an error message or an error symptom occurs, see "Error messages" below. If the problem cannot be resolved, contact your dealer. See **"Requesting service" on page 32**.

## Error messages

If you receive an error message, note the message and take the corrective action. The following table lists the error messages in alphabetical order together with the recommended course of action.

Error messages	Corrective action
CMOS battery bad	Contact your dealer or an authorized service center.
CMOS checksum error	Contact your dealer or an authorized service center.
Disk boot failure	Insert a system (bootable) disk into the floppy drive (A:), then press <Enter> to reboot.
Equipment configuration error	Press <F2> (during POST) to enter the BIOS utility, then press <b>Exit</b> in the BIOS utility to reboot.
Hard disk 0 error	Contact your dealer or an authorized service center.
Hard disk 0 extended type error	Contact your dealer or an authorized service center.
I/O parity error	Contact your dealer or an authorized service center.
Keyboard error or no keyboard connected	Contact your dealer or an authorized service center.
Keyboard interface error	Contact your dealer or an authorized service center.
Memory size mismatch	Press <F2> (during POST) to enter the BIOS utility, then press <b>Exit</b> in the BIOS utility to reboot.

If you still encounter problems after going through the corrective measures, please contact your dealer or an authorized service center for assistance. Some problems may be solved using the BIOS utility.

# Regulations and safety notices

## FCC notice

This device has been tested and found to comply with the limits for a Class B digital device pursuant to Part 15 of the FCC rules. These limits are designed to provide reasonable protection against harmful interference in a residential installation. This device generates, uses, and can radiate radio frequency energy and, if not installed and used in accordance with the instructions, may cause harmful interference to radio communications.

However, there is no guarantee that interference will not occur in a particular installation. If this device does cause harmful interference to radio or television reception, which can be determined by turning the device off and on, the user is encouraged to try to correct the interference by one or more of the following measures:

- Reorient or relocate the receiving antenna.
- Increase the separation between the device and receiver.
- Connect the device into an outlet on a circuit different from that to which the receiver is connected.
- Consult the dealer or an experienced radio/television technician for help.

## Notice: Shielded cables

All connections to other computing devices must be made using shielded cables to maintain compliance with FCC regulations.

## Notice: Peripheral devices

Only peripherals (input/output devices, terminals, printers, etc.) certified to comply with the Class B limits may be attached to this equipment. Operation with non-certified peripherals is likely to result in interference to radio and TV reception.

## Caution

Changes or modifications not expressly approved by the manufacturer could void the user's authority, which is granted by the Federal Communications Commission, to operate this computer.

## Operation conditions

This device complies with Part 15 of the FCC Rules. Operation is subject to the following two conditions: (1) this device may not cause harmful interference, and (2) this device must accept any interference received, including interference that may cause undesired operation.

## Notice: Canadian users

This Class B digital apparatus complies with Canadian ICES-003.

## Remarque à l'intention des utilisateurs canadiens

Cet appareil numérique de la classe B est conforme à la norme NMB-003 du Canada.

## Declaration of Conformity for EU countries

Hereby, Acer, declares that this notebook PC series is in compliance with the essential requirements and other relevant provisions of Directive 1999/5/EC. (Please visit <http://global.acer.com/products/notebook/reg-nb/index.htm> for complete documents.)

Compliant with Russian regulatory certification



ME61

## Modem notices

### Notice for USA

This equipment complies with Part 68 of the FCC rules. Located on the modem is a label that contains, among other information, the FCC Registration Number and Ringer Equivalence Number (REN) for this equipment. Upon request, you must provide this information to your telephone company.

If your telephone equipment causes harm to the telephone network, the telephone company may discontinue your service temporarily. If possible, they will notify you in advance. But, if advance notice is not practical, you will be notified as soon as possible. You will also be informed of your right to file a complaint with the FCC.

Your telephone company may make changes in its facilities, equipment, operations, or procedures that could affect the proper functioning of your equipment. If they do, you will be notified in advance to give you an opportunity to maintain uninterrupted telephone service.

If this equipment should fail to operate properly, disconnect the equipment from the phone line to determine if it is causing the problem. If the problem is with the equipment, discontinue use and contact your dealer or vendor.



.....  
**Caution:** To reduce the risk of fire, use only No. 26 AWG or larger UL Listed or CSA Certified Telecommunication Line Cord.

## TBR 21

This equipment has been approved [Council Decision 98/482/EC - "TBR 21"] for single terminal connection to the Public Switched Telephone Network (PSTN). However, due to differences between the individual PSTNs provided in different countries, the approval does not, of itself, give an unconditional assurance of successful operation on every PSTN termination point. In the event of problems, you should contact your equipment supplier in the first instance.

## List of applicable countries

EU member states as of May 2004 are: Belgium, Denmark, Germany, Greece, Spain, France, Ireland, Italy, Luxembourg, the Netherlands, Austria, Portugal, Finland, Sweden, United Kingdom Estonia, Latvia, Lithuania, Poland, Hungary, Czech Republic, Slovak Republic, Slovenia, Cyprus and Malta. Usage allowed in the countries of European Union, as well as Norway, Switzerland, Iceland and Liechtenstein. This device must be used in strict accordance with the regulations and constraints in the country of use. For further information, please contact local office in the country of use.

## Notice for Australia

For safety reasons, only connect headsets with a telecommunications compliance label. This includes customer equipment previously labelled permitted or certified.

## Notice for New Zealand

- 1 The grant of a Telepermit for any item of terminal equipment indicates only that Telecom has accepted that the item complies with minimum conditions for connection to its network. It indicates no endorsement of the product by Telecom, nor does it provide any sort of warranty. Above all, it provides no assurance that any item will work correctly in all respects with another item of Telepermitted equipment of a different make or model, nor does it imply that any product is compatible with all of Telecom's network services.
- 2 This equipment is not capable, under all operating conditions, of correct operation at the higher speeds for which it is designed. Telecom will accept no responsibility should difficulties arise in such circumstances.
- 3 Some parameters required for compliance with Telecom's Telepermit requirements are dependent on the equipment (PC) associated with this device. The associated equipment shall be set to operate within the following limits for compliance with Telecom's Specifications:
  - a There shall be no more than 10 call attempts to the same number within any 30 minute period for any single manual call initiation, and
  - b The equipment shall go on-hook for a period of not less than 30 seconds between the end of one attempt and the beginning of the next call attempt.
- 4 Some parameters required for compliance with Telecom's Telepermit requirements are dependent on the equipment (PC) associated with this device. In order to operate within the limits for compliance with Telecom's specifications, the associated equipment shall be set to ensure that automatic calls to different numbers are spaced such that there is not less than 5 seconds between the end of one call attempt and the beginning of another.
- 5 This equipment shall not be set up to make automatic calls to Telecom's 111 Emergency Service.
- 6 This device is equipped with pulse dialing while the Telecom standard is DTMF tone dialing. There is no guarantee that Telecom lines will always continue to support pulse dialing.
- 7 Use of pulse dialing, when this equipment is connected to the same line as other equipment, may give rise to bell tinkle or noise and may also cause a false answer condition. Should such problems occur, the user should NOT contact the telecom Fault Service.
- 8 This equipment may not provide for the effective hand-over of a call to another device connected to the same line.
- 9 Under power failure conditions this appliance may not operate. Please ensure that a separate telephone, not dependent on local power, is available for emergency use.



## Laser compliance statement

The CD or DVD drive used with this computer is a laser product.  
The CD or DVD drive's classification label (shown below) is located on the drive.

CLASS 1 LASER PRODUCT

CAUTION: INVISIBLE LASER RADIATION WHEN OPEN. AVOID EXPOSURE TO BEAM.

APPAREIL A LASER DE CLASSE 1 PRODUIT

LASERATTENTION: RADIATION DU FAISCEAU LASER INVISIBLE EN CAS D'OUVERTURE. EVITER TOUTE EXPOSITION AUX RAYONS.

LUOKAN 1 LASERLAITE LASER KLASSE 1

VORSICHT: UNSICHTBARE LASERSTRAHLUNG, WENN ABDECKUNG GEÖFFNET NICHT DEM STRAHL AUSSETZEN

PRODUCTO LÁSER DE LA CLASE I

ADVERTENCIA: RADIACIÓN LÁSER INVISIBLE AL SER ABIERTO. EVITE EXPONERSE A LOS RAYOS.

ADVARSEL: LASERSTRÅLING VED ÅBNING SE IKKE IND I STRÅLEN.

VARO! LAVATTAESSA OLET ALTTINA LASERSÄTEILYLLE.

WARNING: LASERSTRÅLNING NÅR DENNA DEL ÅR ÖPPNAD ÅLÅ TUIJOTA SÄTEESEENSTIRRA EJ IN I STRÅLEN

WARNING: LASERSTRÅLNING NAR DENNA DEL ÅR ÖPPNADSTIRRA EJ IN I STRÅLEN

ADVARSEL: LASERSTRÅLING NAR DEKSEL ÅPNESSTIRR IKKE INN I STRÅLEN

## LCD pixel statement

The LCD unit is produced with high-precision manufacturing techniques. Nevertheless, some pixels may occasionally misfire or appear as black or red dots. This has no effect on the recorded image and does not constitute a malfunction.

# Radio device regulatory notice



**Note:** Below regulatory information is for models with wireless LAN and / or Bluetooth only.

## General

This product complies with the radio frequency and safety standards of any country or region in which it has been approved for wireless use. Depending on configurations, this product may or may not contain wireless radio devices (such as wireless LAN and/or Bluetooth modules). Below information is for products with such devices.

## European Union (EU)

R&TTE Directive 1999/5/EC as attested by conformity with the following harmonized standard:

- **Article 3.1(a) Health and Safety**
  - EN60950-1:2001+ A11:2004
  - EN50371:2002
- **Article 3.1(b) EMC**
  - EN301 489-1 V1.6.1
  - EN301 489-3 V1.4.1
  - EN301 489-17 V1.2.1
- **Article 3.2 Spectrum Usages**
  - EN300 220-3 V1.1.1
  - EN300 328 V1.7.1
  - EN300 440-2 V1.1.2
  - EN301 893 V1.2.3



## List of applicable countries

EU member states as of May 2004 are: Belgium, Denmark, Germany, Greece, Spain, France, Ireland, Italy, Luxembourg, the Netherlands, Austria, Portugal, Finland, Sweden, United Kingdom Estonia, Latvia, Lithuania, Poland, Hungary, Czech Republic, Slovak Republic, Slovenia, Cyprus and Malta. Usage allowed in the countries of European Union, as well as Norway, Switzerland, Iceland and Liechtenstein. This device must be used in strict accordance with the regulations and constraints in the country of use. For further information, please contact local office in the country of use.

## The FCC RF safety requirement

The radiated output power of the wireless LAN Mini PCI Card and Bluetooth card is far below the FCC radio frequency exposure limits. Nevertheless, the notebook PC series shall be used in such a manner that the potential for human contact during normal operation is minimized as follows:

- 1 Users are requested to follow the RF safety instructions on wireless option devices that are included in the user's manual of each RF option device.



**Caution:** To comply with FCC RF exposure compliance requirements, a separation distance of at least 20 cm (8 inches) must be maintained between the antenna for the integrated wireless LAN Mini PCI Card built in to the screen section and all persons.

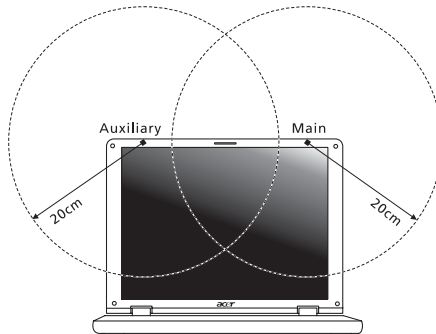

**Note:** The Acer wireless Mini PCI adapter implements a transmission diversity function. The function does not emit radio frequencies simultaneously from both antennas. One of the antennas is selected automatically or manually (by users) to ensure good quality radiocommunication.

- 2 This device is restricted to indoor use due to its operation in the 5.15 to 5.25 GHz frequency range. FCC requires this product to be used indoors for the frequency range 5.15 to 5.25 GHz to reduce the potential for harmful interference to co-channel Mobile Satellite systems.
- 3 High power radar are allocated as primary users of the 5.25 to 5.35 GHz and 5.65 to 5.85 GHz bands. These radar stations can cause interference with and/or damage this device.
- 4 An improper installation or unauthorized use may cause harmful interference to radio communications. Also any tampering of the internal antenna will void the FCC certification and your warranty.

## Canada — Low-power license-exempt radio communication devices (RSS-210)

- a Common information  
Operation is subject to the following two conditions:
    1. This device may not cause interference, and
    2. This device must accept any interference, including interference that may cause undesired operation of the device.
  - b Operation in 2.4 GHz band  
To prevent radio interference to the licensed service, this device is intended to be operated indoors and installation outdoors is subject to licensing.
  - c Operation in 5 GHz band
- The device for the band 5150-5250 MHz is only for indoor usage to reduce potential for harmful interference to co-channel Mobile Satellite systems.
  - High power radars are allocated as primary users (meaning they have priority) of 5250-5350 MHz and 5650-5850 MHz and these radars could cause interference and/or damage to LELAN (Licence-Exempt Local Area Network) devices.

## LCD panel ergonomic specifications

Design viewing distance	500 mm
Design inclination angle	0.0°
Design azimuth angle	90.0°
Viewing direction range class	Class IV
Screen tilt angle	85.0°
Design screen illuminance	<ul style="list-style-type: none"> <li>• Illuminance level: [250 + (250cos<math>\alpha</math>)] lx where <math>\alpha = 85^\circ</math></li> <li>• Color: Source D65</li> </ul>
Reflection class of LCD panel (positive and negative polarity)	<ul style="list-style-type: none"> <li>• Ordinary LCD: Class I</li> <li>• Protective or Acer CrystalBrite™ LCD: Class III</li> </ul>
Image polarity	Both
Reference white:	<ul style="list-style-type: none"> <li>• Yn</li> </ul>
Pre-setting of luminance and color temperature @ 6500K (tested under BM7)	<ul style="list-style-type: none"> <li>• u'n</li> <li>• v'n</li> </ul>
Pixel fault class	Class II

# Index

## A

- AC adapter
  - caring for xv
- audio
  - troubleshooting 41

## B

- battery pack
  - battery-low warning 48
  - caring for xvi
  - characteristics 45
  - charging 47
  - checking charge level 47
  - installing 46
  - low conditions 48
  - maximizing life 45
  - optimizing 47
  - removing 47
  - using the first time 45

BIOS utility 71

- brightness
  - hotkeys 30

## C

- caps lock 28
  - on indicator 24
- care
  - AC adapter xv
  - battery pack xvi
  - computer xv

## CD-ROM

- ejecting manually 42
- troubleshooting 42

## charging

- checking level 47

## cleaning

- computer xvi

## computer

- caring for xv
- cleaning xvi
- disconnecting 57
- features 15, 39
- indicators 24
- keyboards 28
- moving around 57
- on indicator 24, 25

- security 61
- setting up a home office 59
- taking home 58
- traveling internationally 60
- traveling on local trips 59
- troubleshooting 77
- turning off xv

- connections
  - network 64

## D

- display
  - hotkeys 30
  - troubleshooting 41
- DVD 72
- DVD movies
  - playing 72

## E

- error messages 77
- Euro 31

## F

- FAQ. See frequently-asked questions
- frequently-asked questions 41
- front view 17

## H

- Hibernation mode
  - hotkey 30
- hotkeys 30

## K

- keyboard 28
  - embedded numeric keypad 28
  - hotkeys 30
  - lock keys 28
  - troubleshooting 42
  - Windows keys 29

## L

- left view 17

## M

- media access
  - on indicator 24
- memory
  - installing 67
- messages
  - error 77

modem 63

## N

network 64

Notebook Manager  
hotkey 30

num lock 28  
on indicator 24

numeric keypad  
embedded 28

## P

password 61  
types 61

ports 63

printer  
troubleshooting 42

problems 41  
CD-ROM 42  
display 41  
keyboard 42  
printer 42  
startup 41  
troubleshooting 77

## Q

questions  
setting location for modem use  
42

## S

safety  
CD or DVD 83

modem notices 80

scroll lock 28

security  
keylock 32, 61  
passwords 61

speakers  
hotkey 30  
troubleshooting 41

support  
information 44

## T

touchpad 26  
hotkey 30  
using 26, 26– 27

travel  
international flights 60  
local trips 59  
troubleshooting 77  
tips 77

## U

universal serial bus 65

## V

view  
front 18  
left 18  
rear 20  
right 19

## W

Windows keys 29